

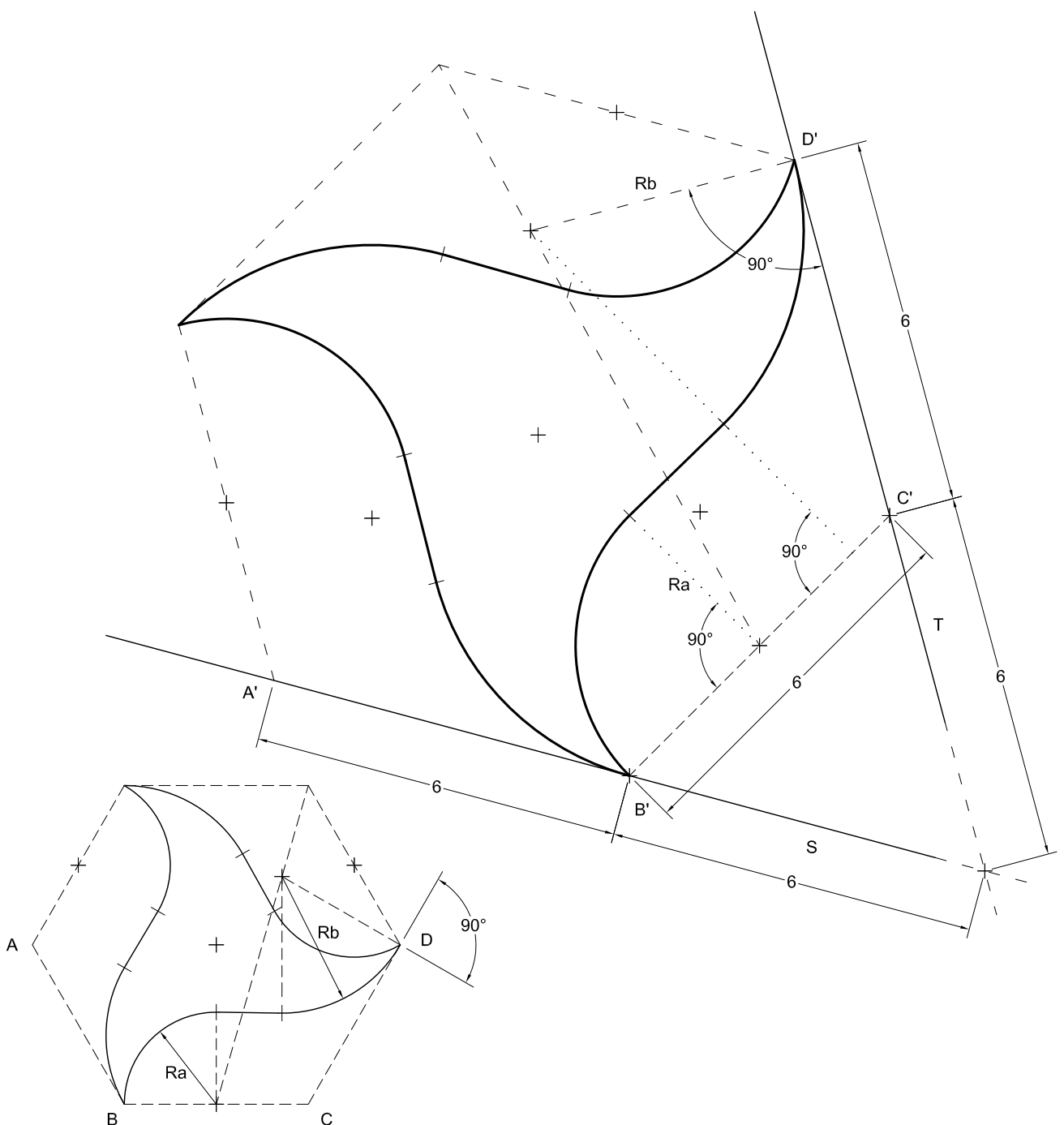

SÈRIE 2

(1A)

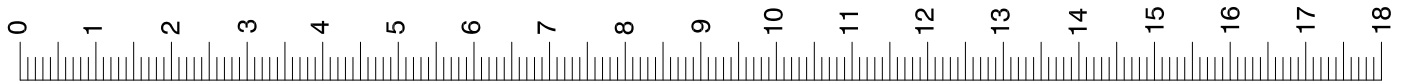



(1B)

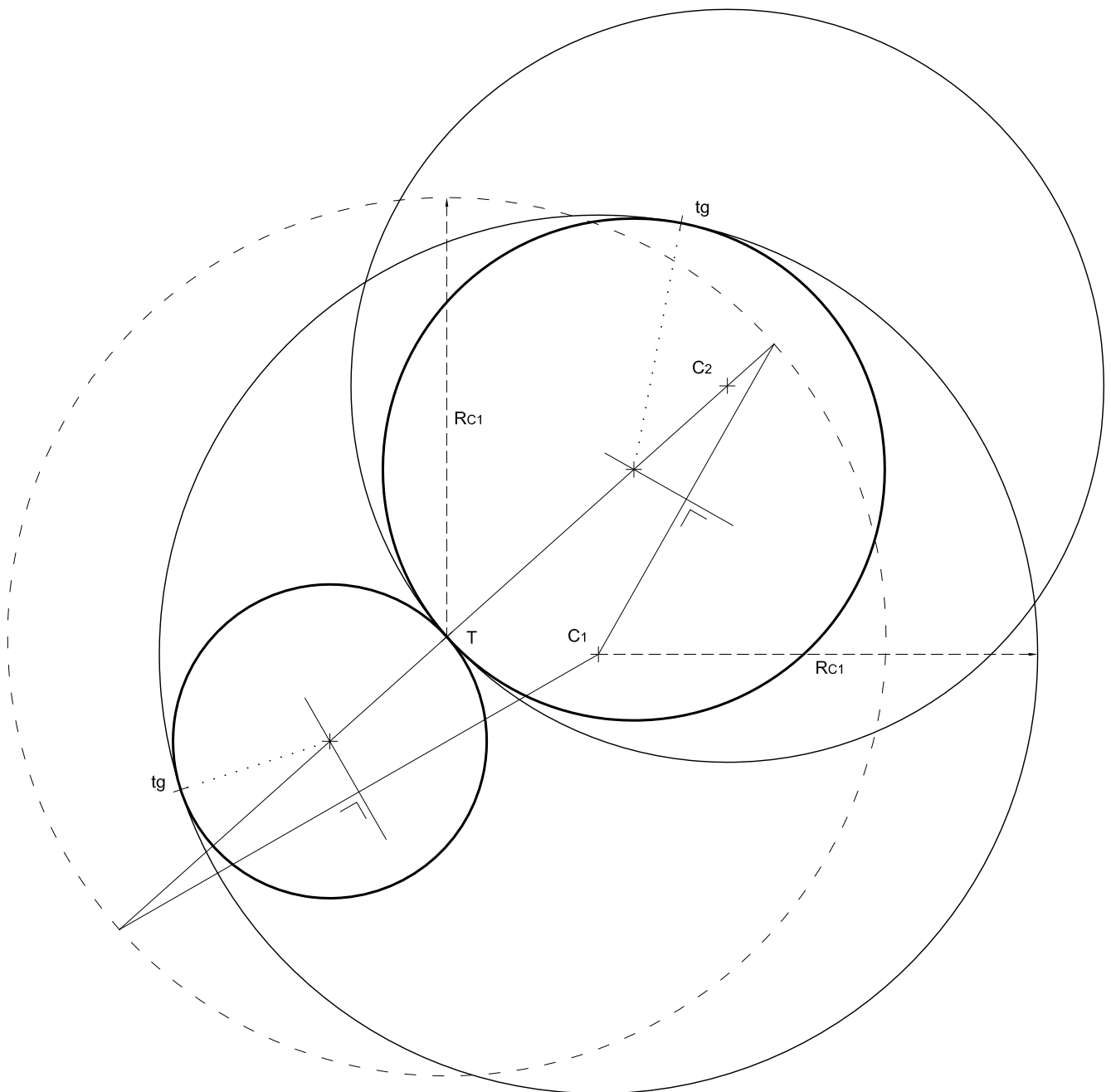
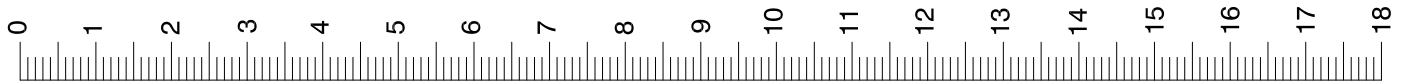



(2A)

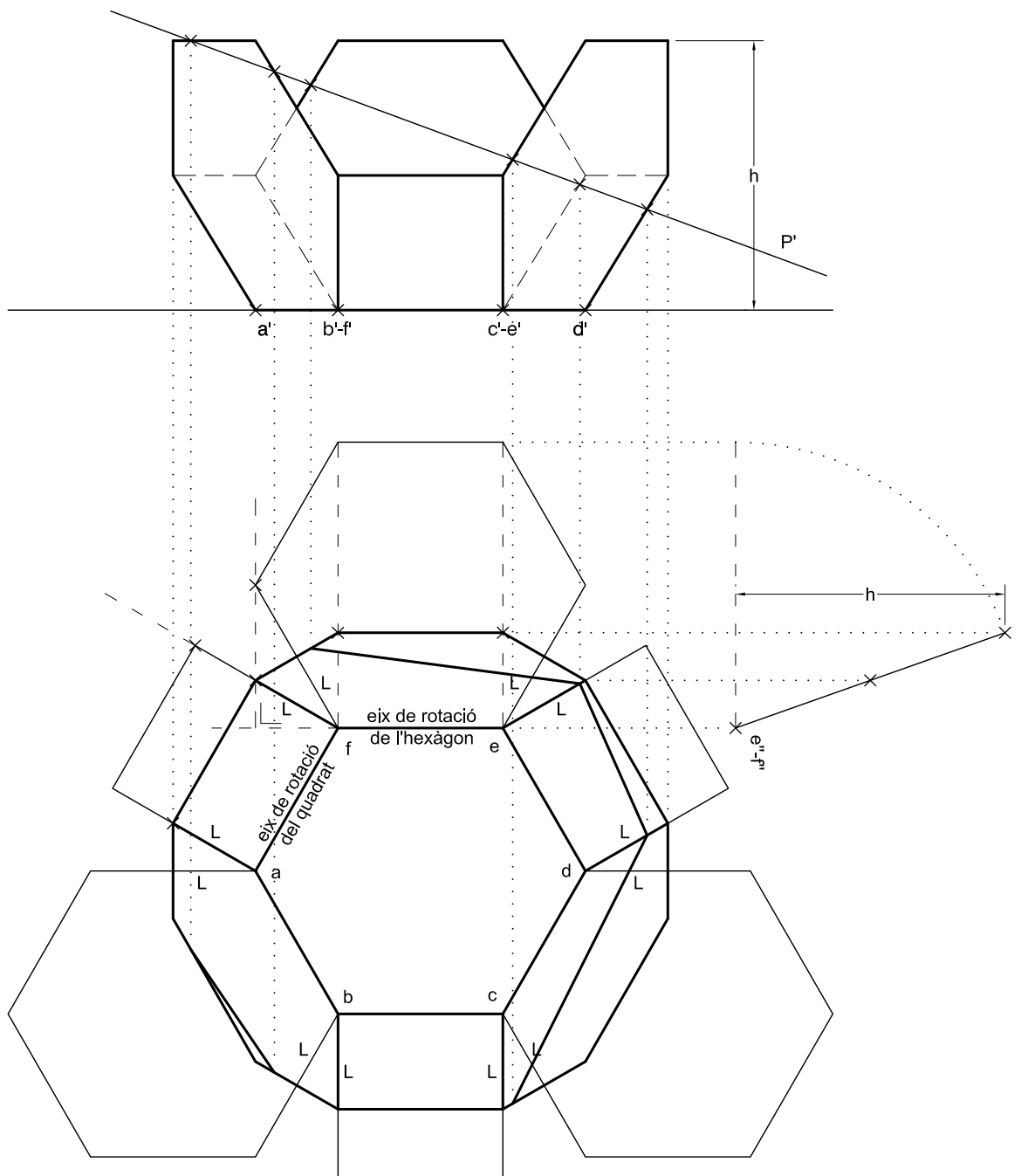
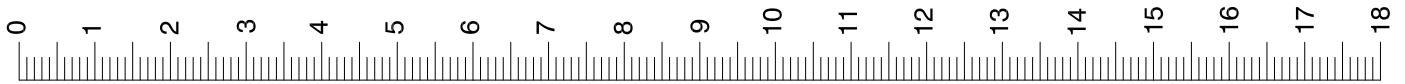



(2B)

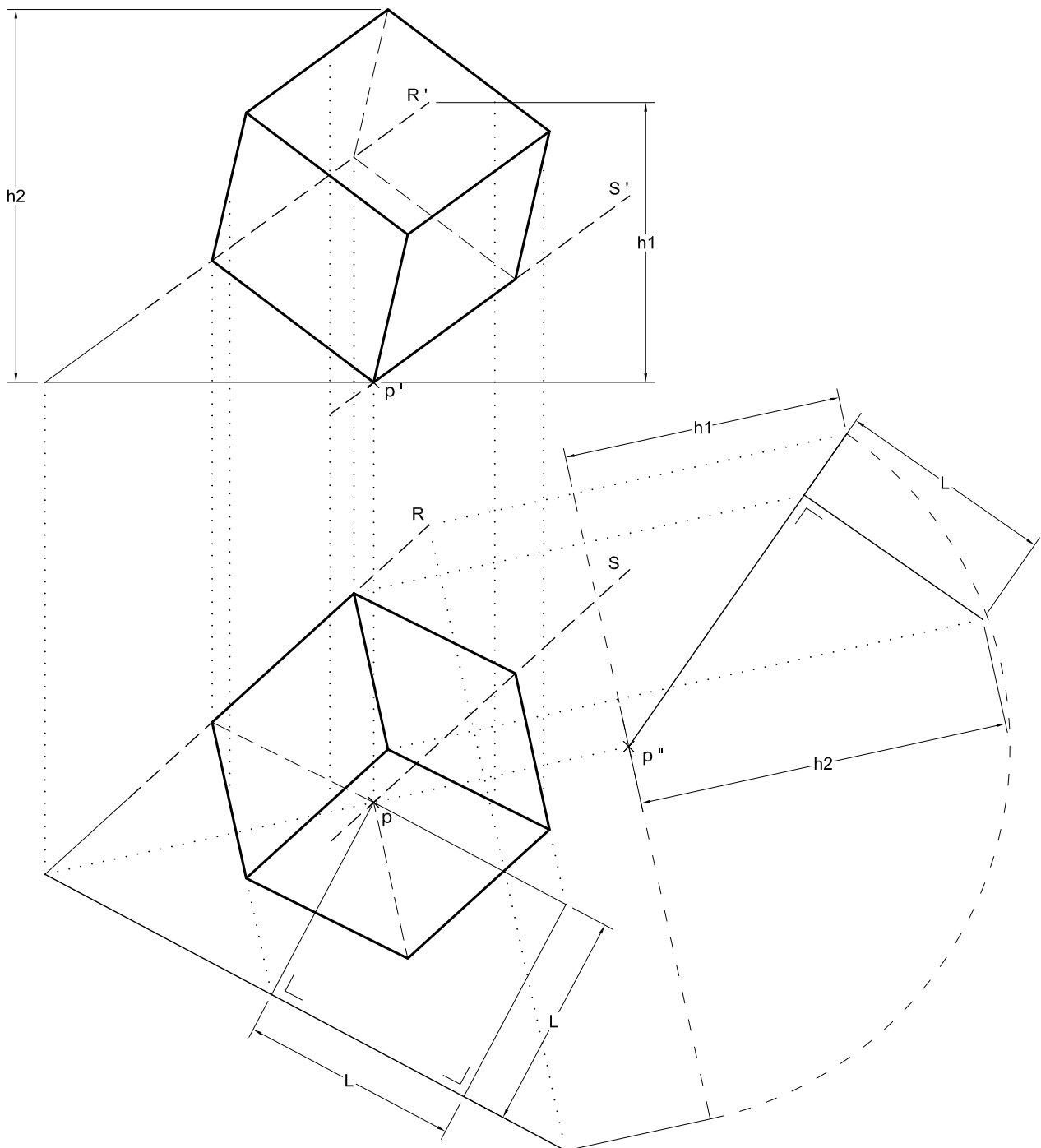
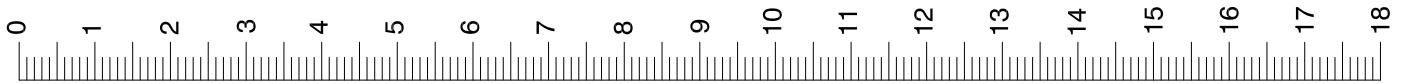



(3A)

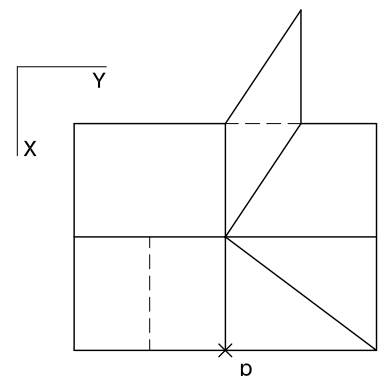
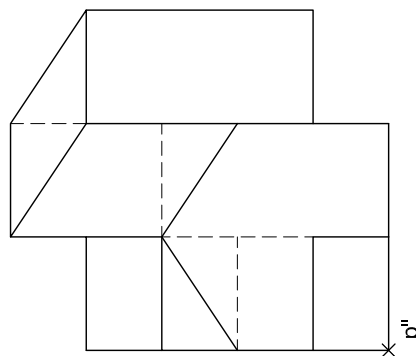
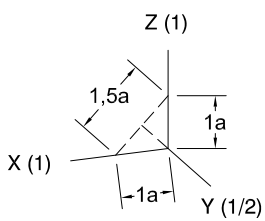
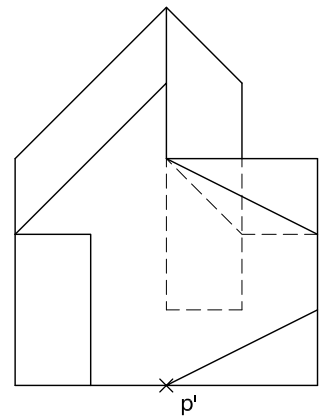
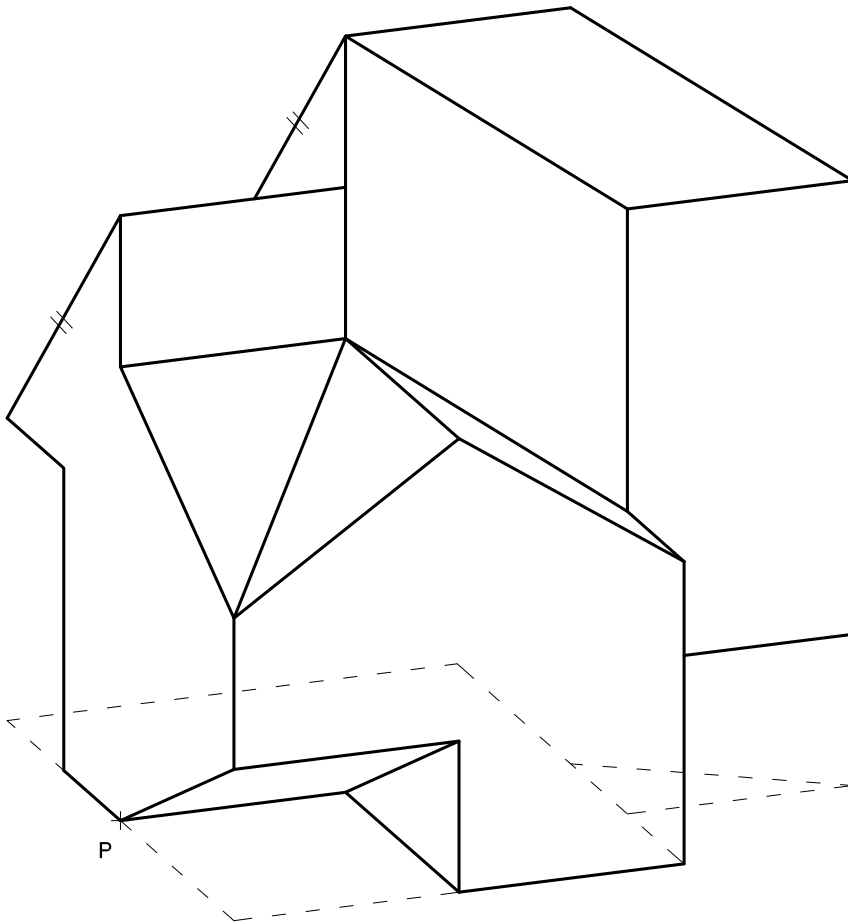
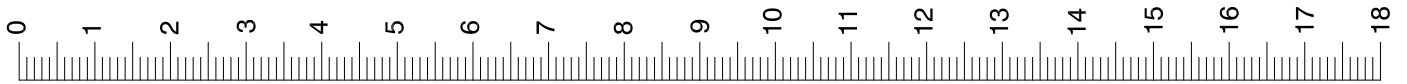



(3B)

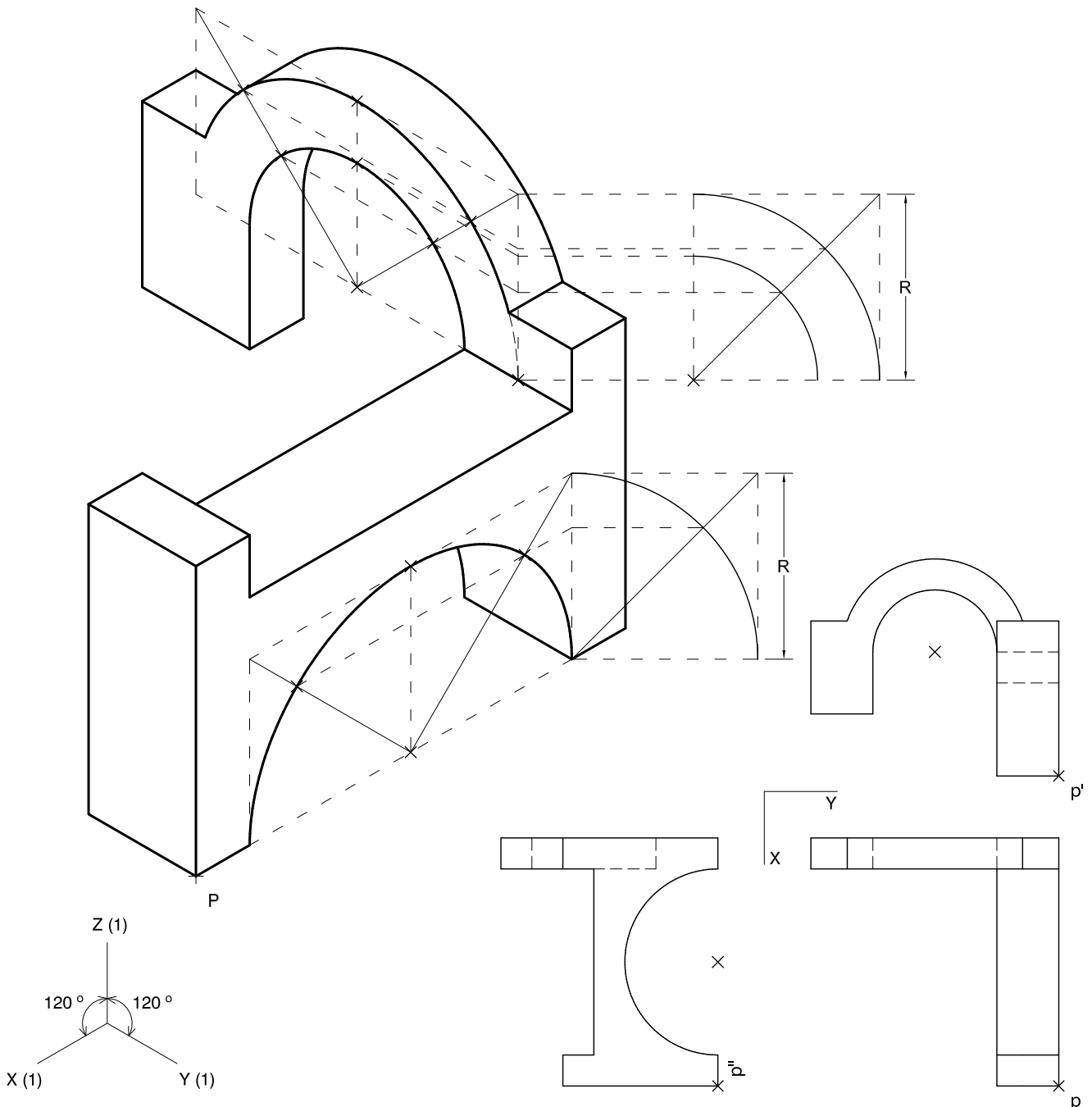
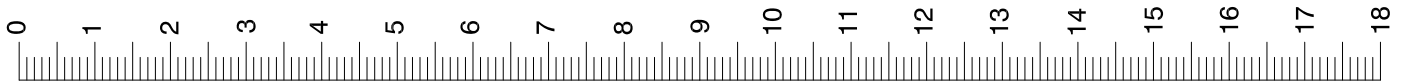



SÈRIE 5

(1A)

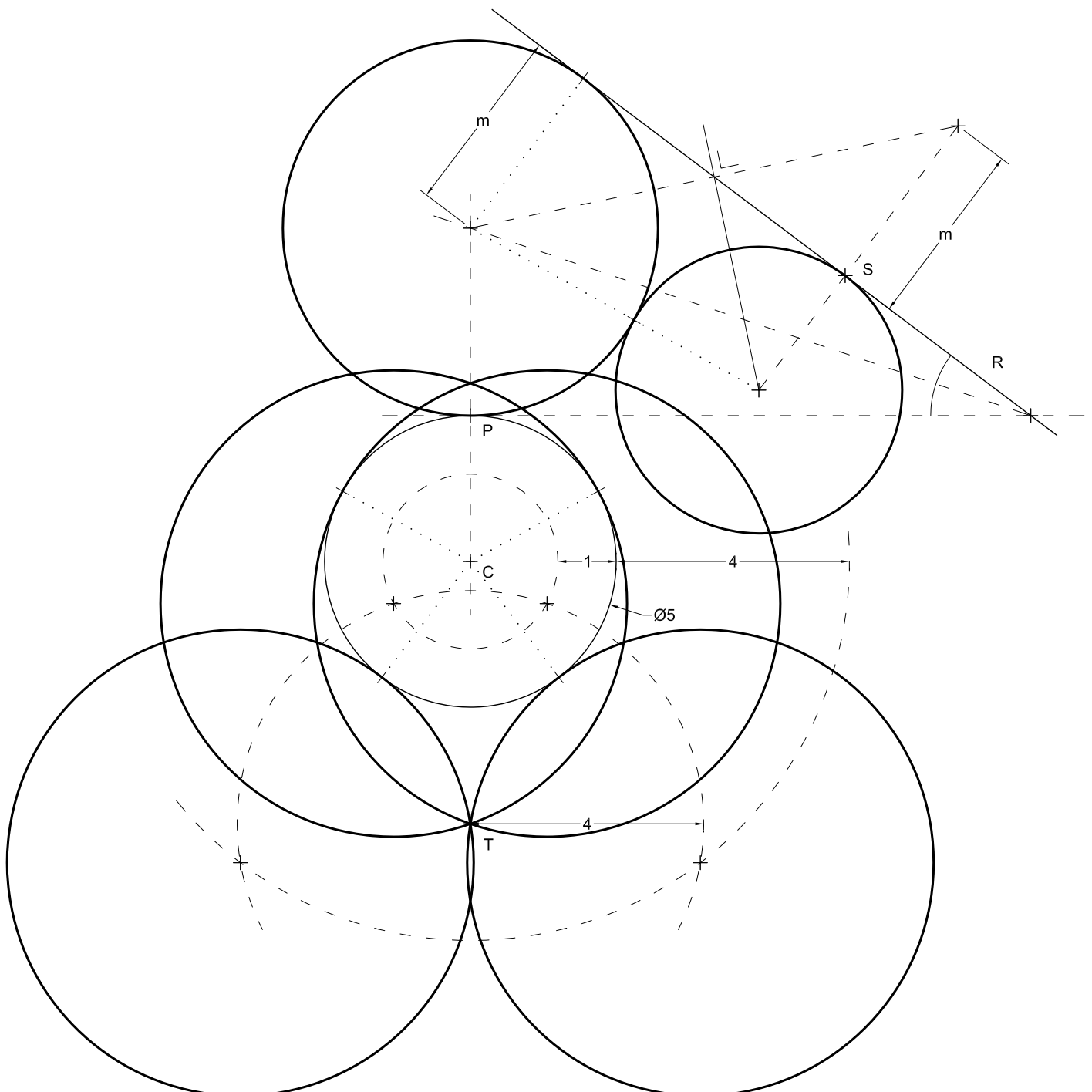
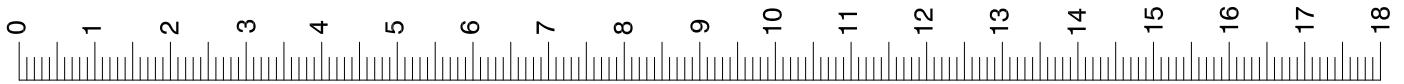



(1B)

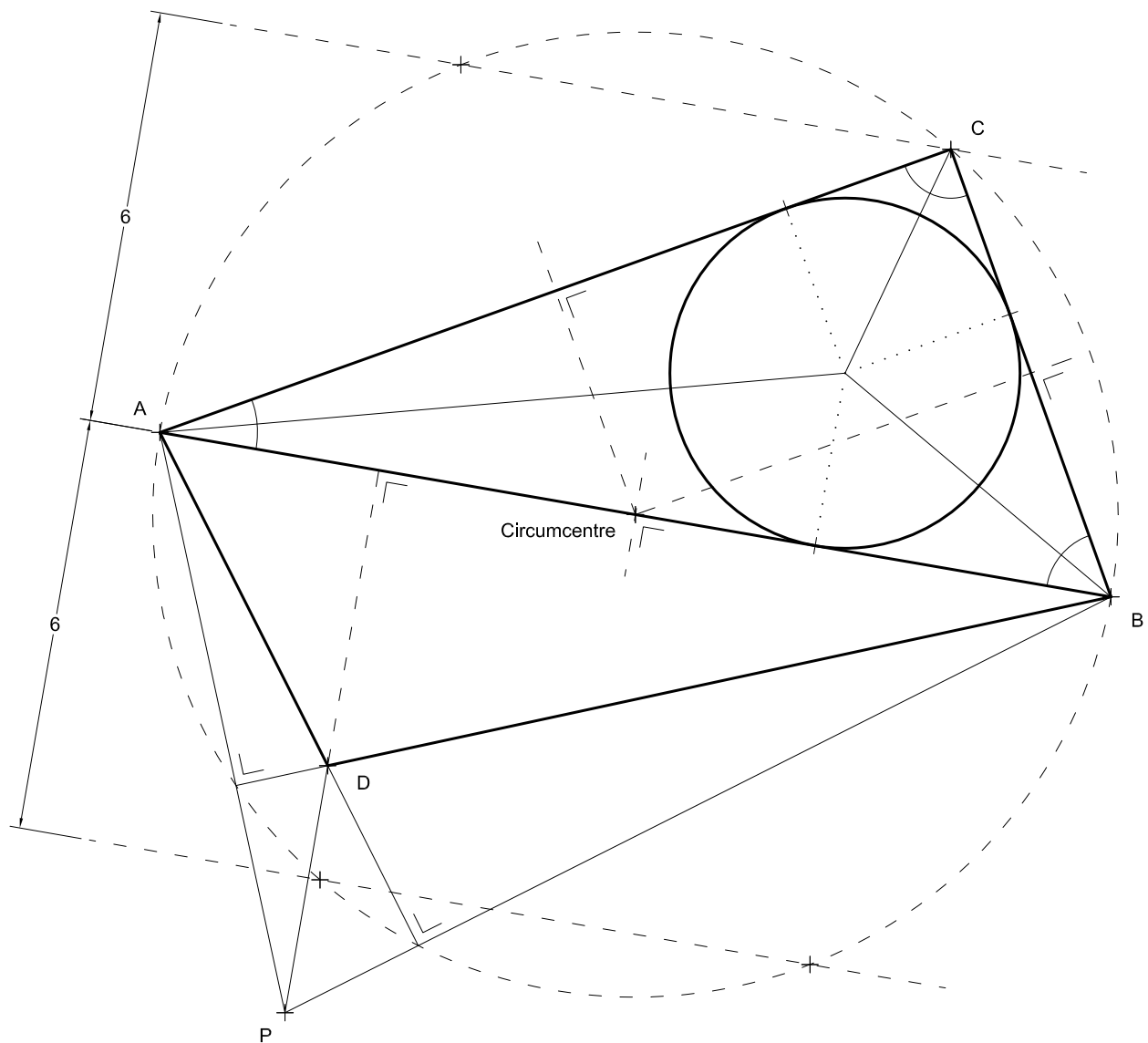
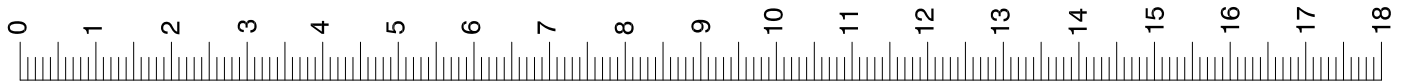

Segment AB : 10,5 metres



(2A)

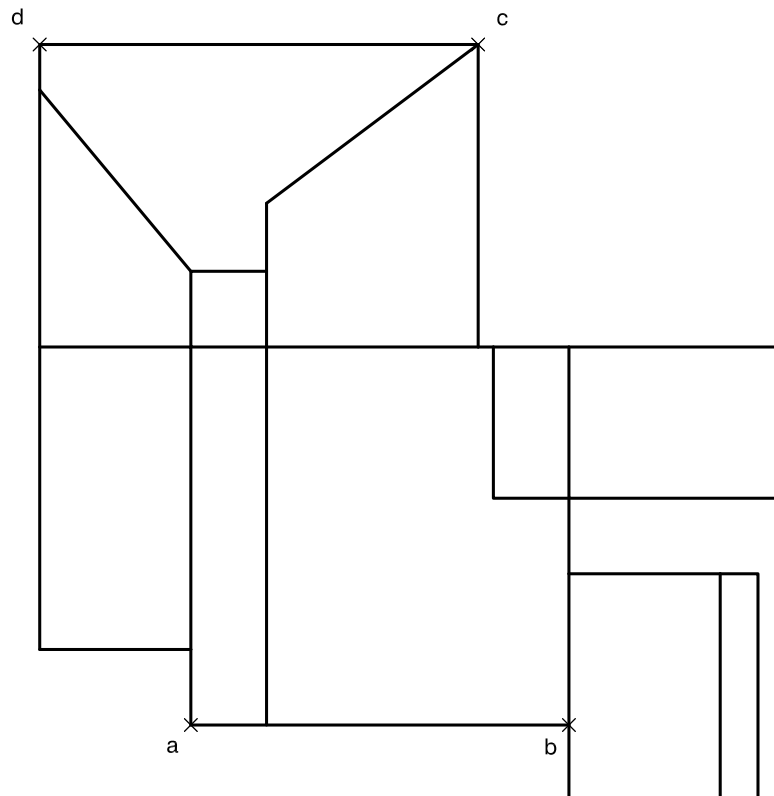
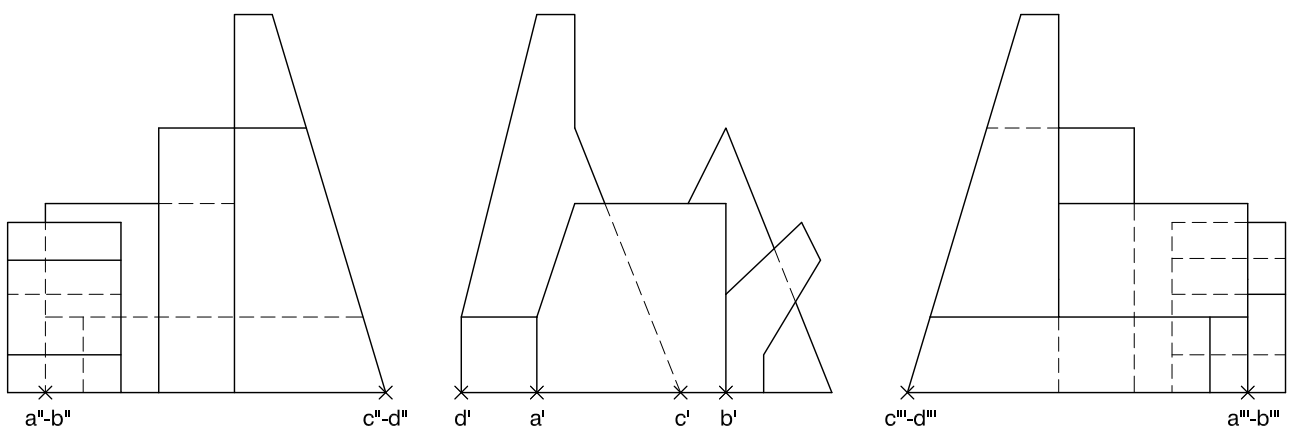
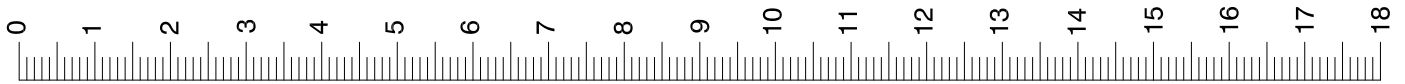



(2B)

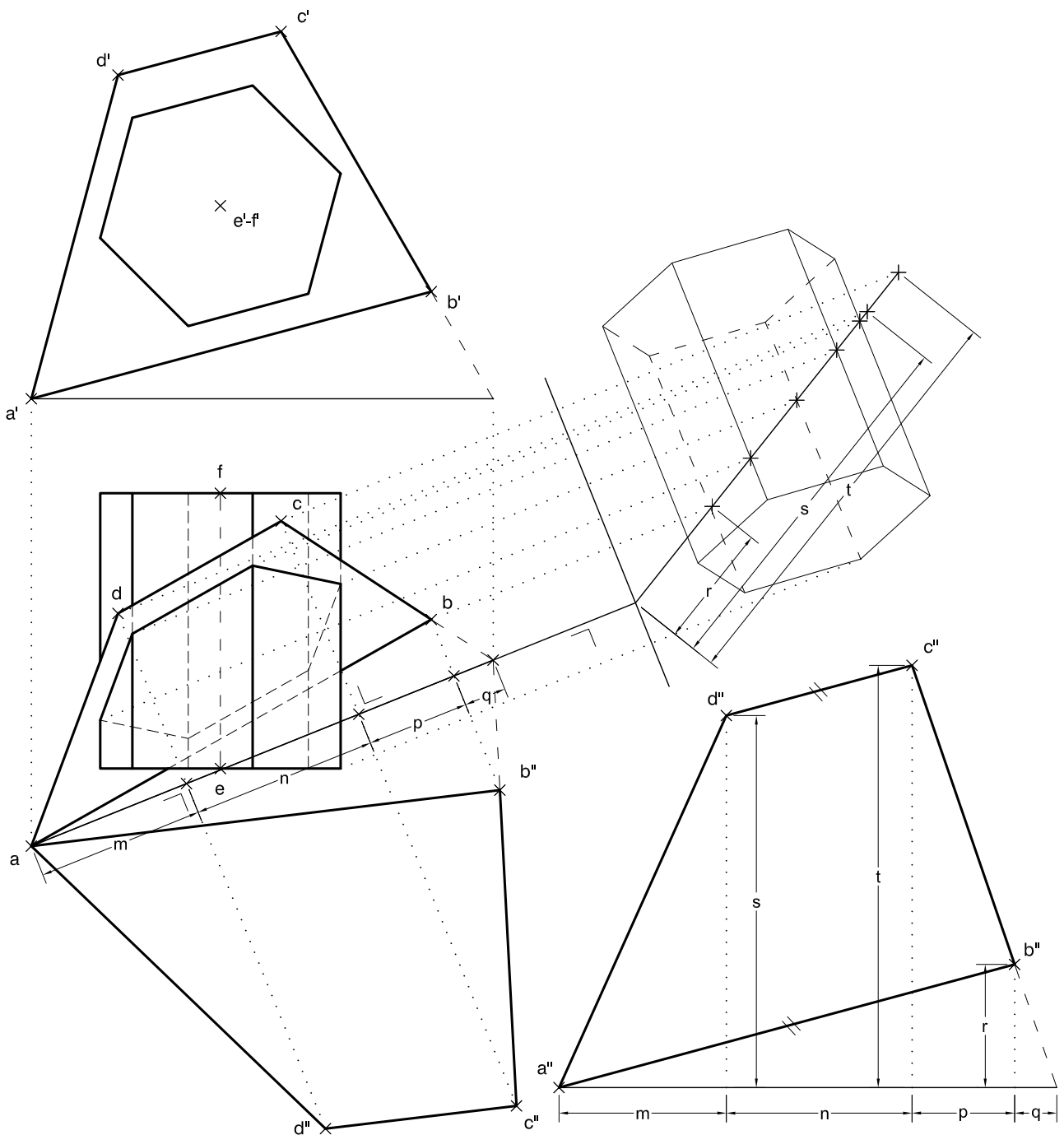
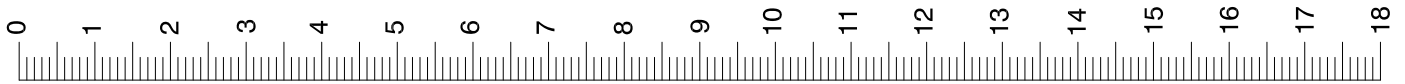



(3A)

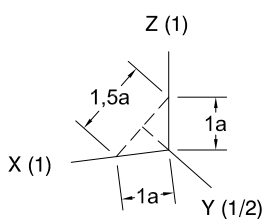
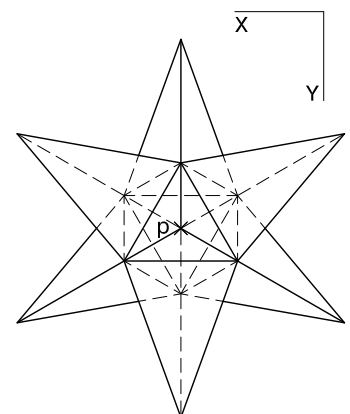
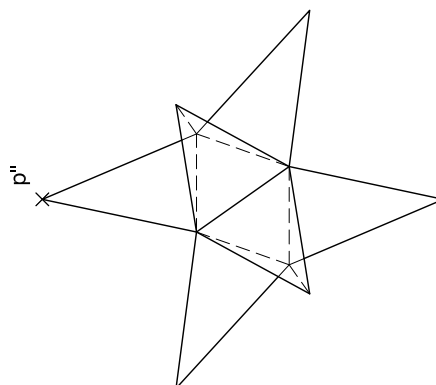
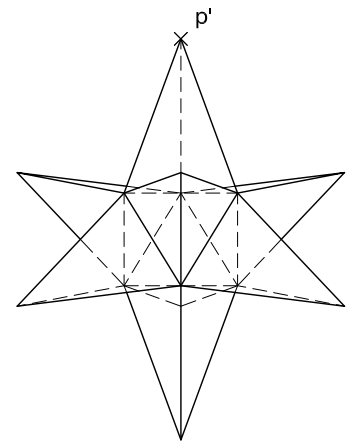
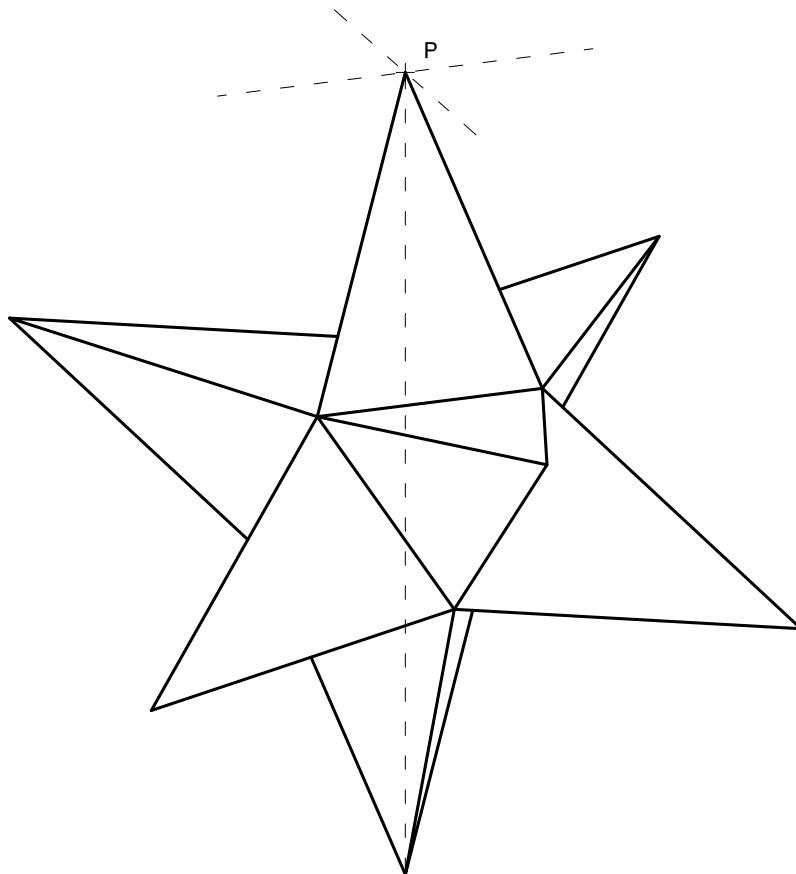
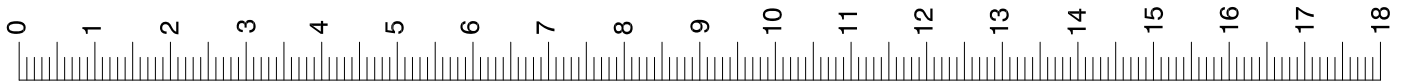



(3B)

