

# S2.1

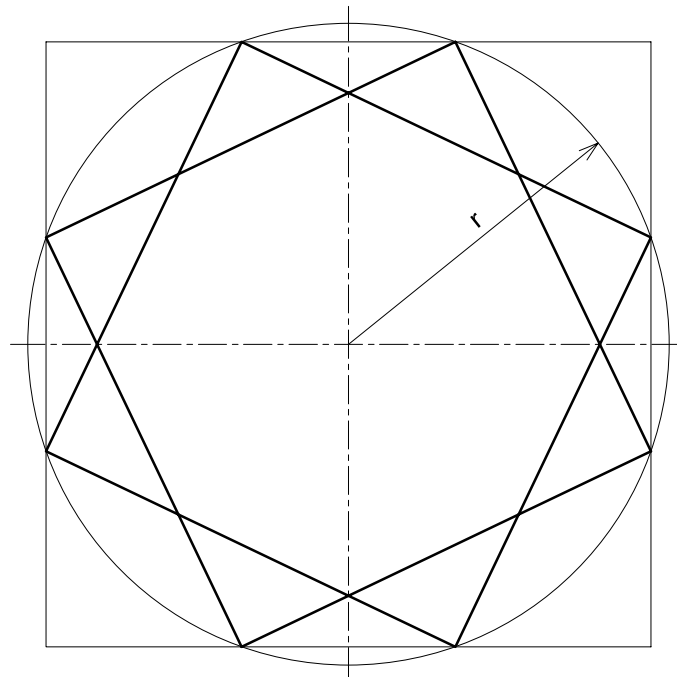

qualsevol dels dos quadrats és vàlid

S2.2A

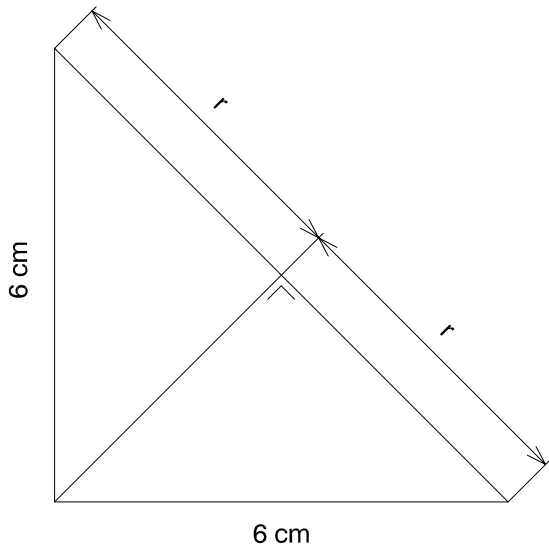
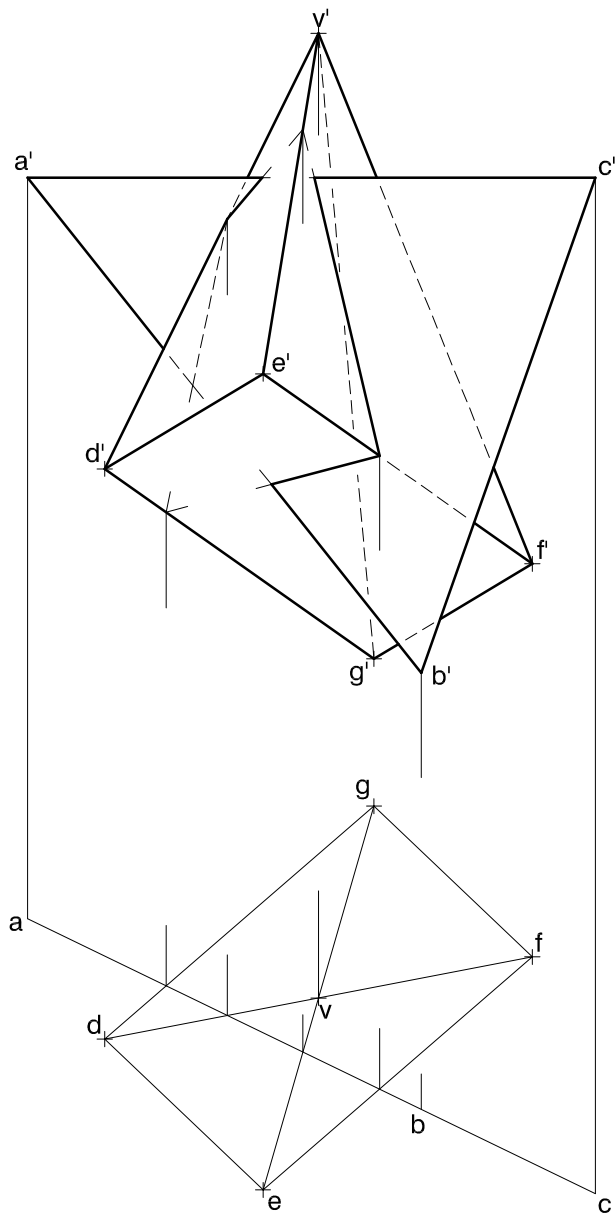

# S2.2B

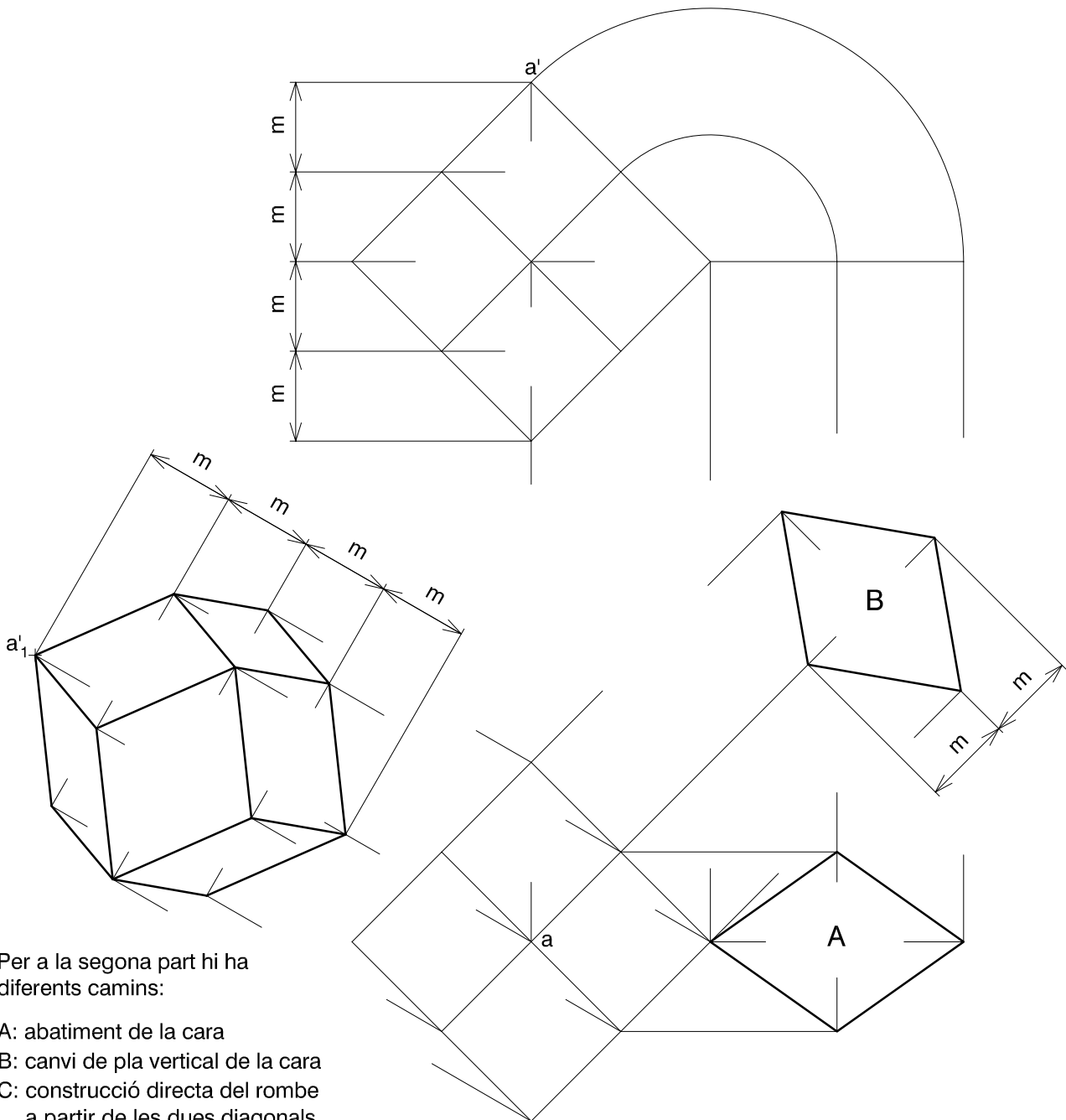

Per a la segona part hi ha diferents camins:

- A: abatiment de la cara
- B: canvi de pla vertical de la cara
- C: construcció directa del rombe a partir de les dues diagonals

# S2.3A

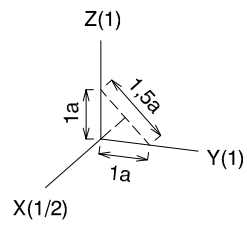
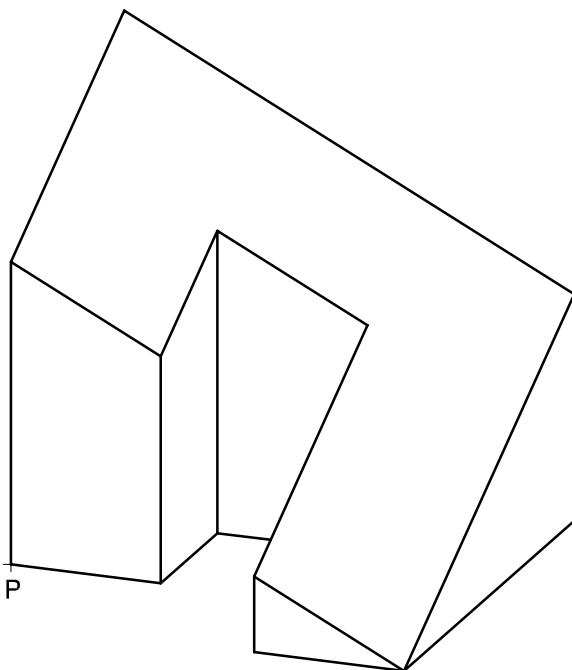
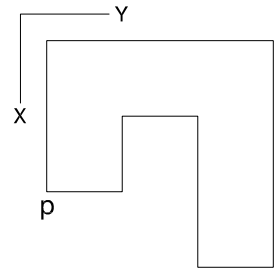
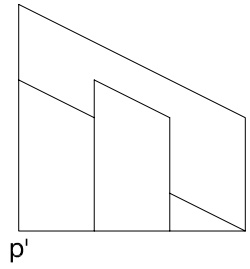
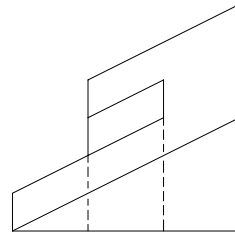

# S2.3B

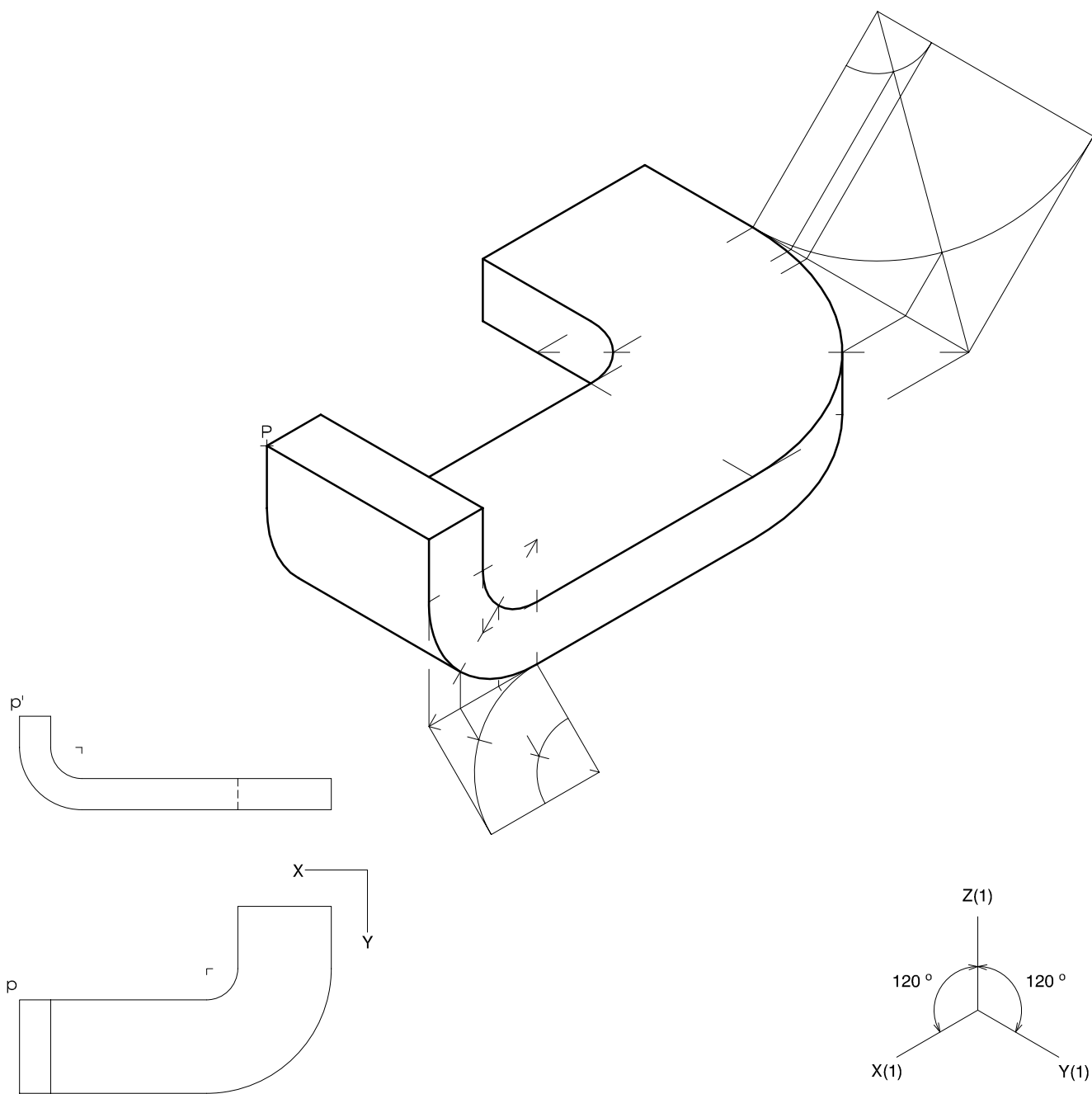

S1.1

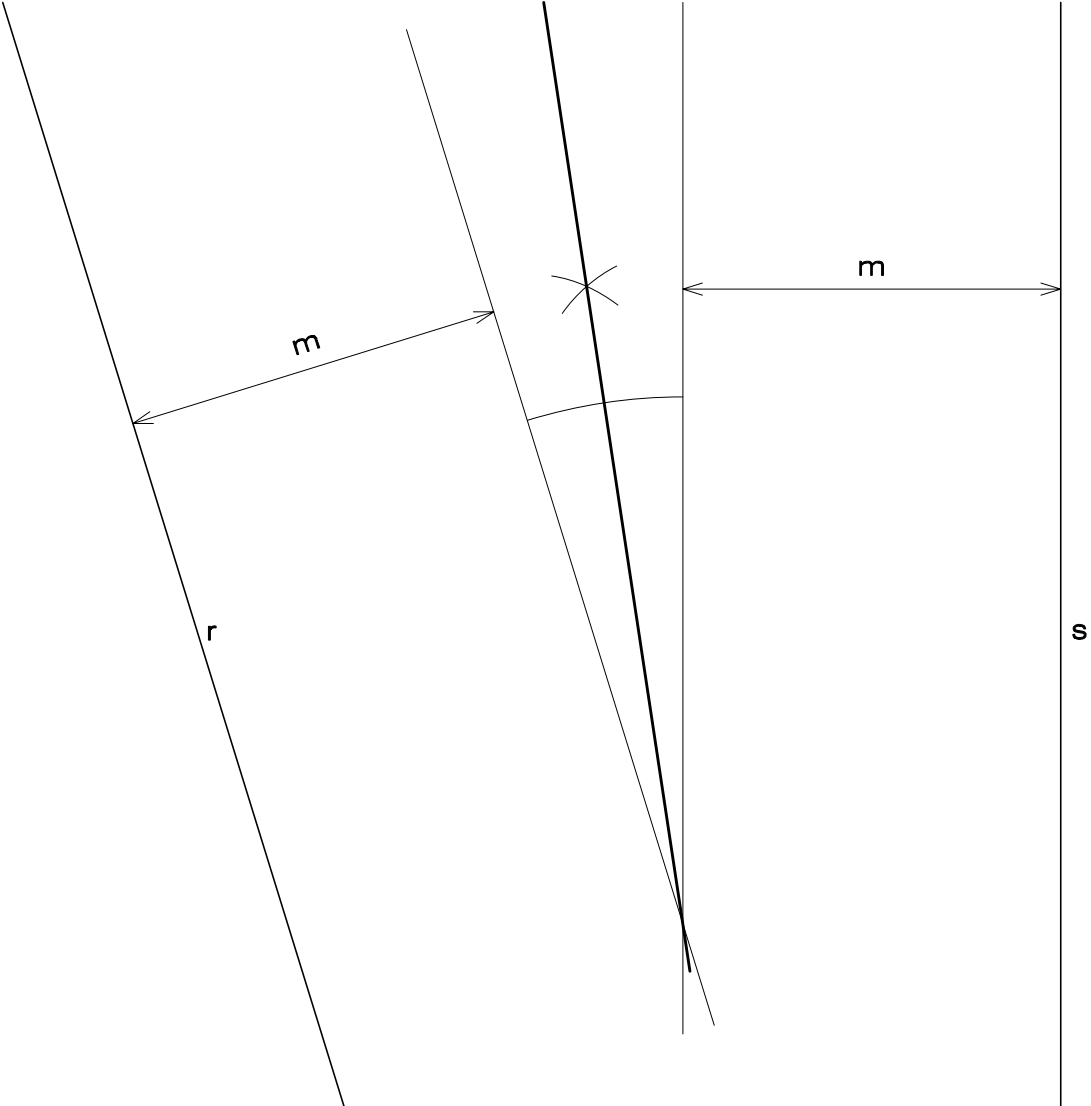

S1.2A

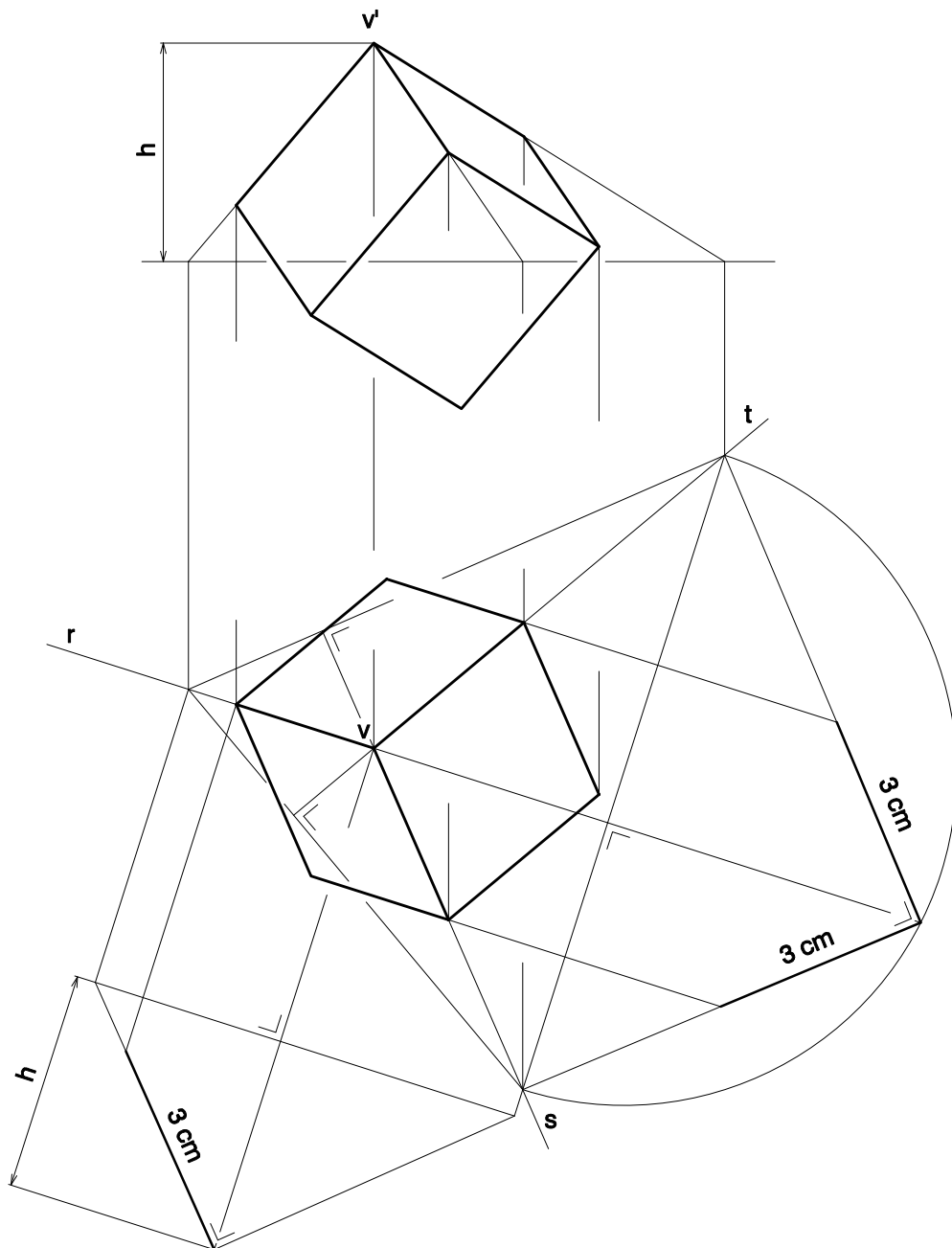

S1.2B

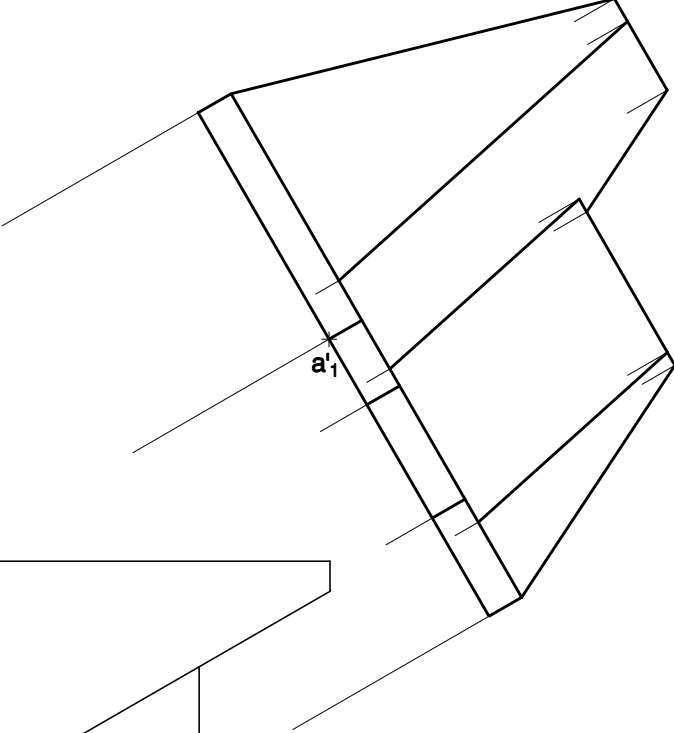
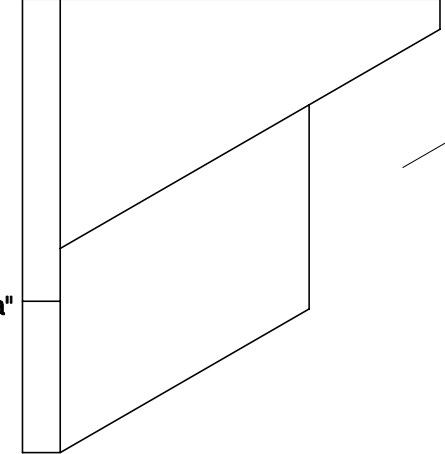
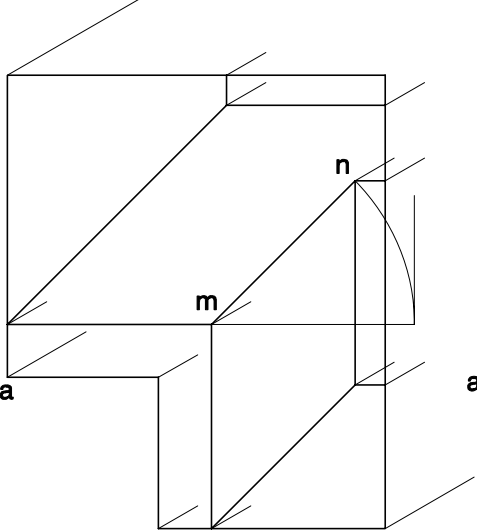
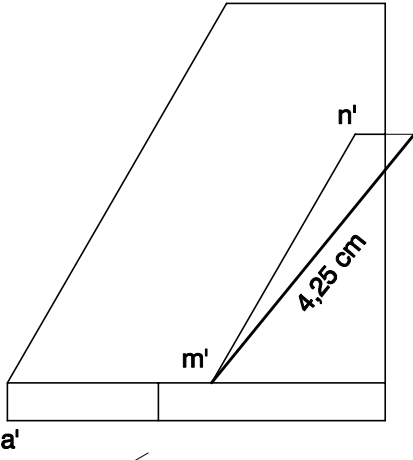



S1.3A

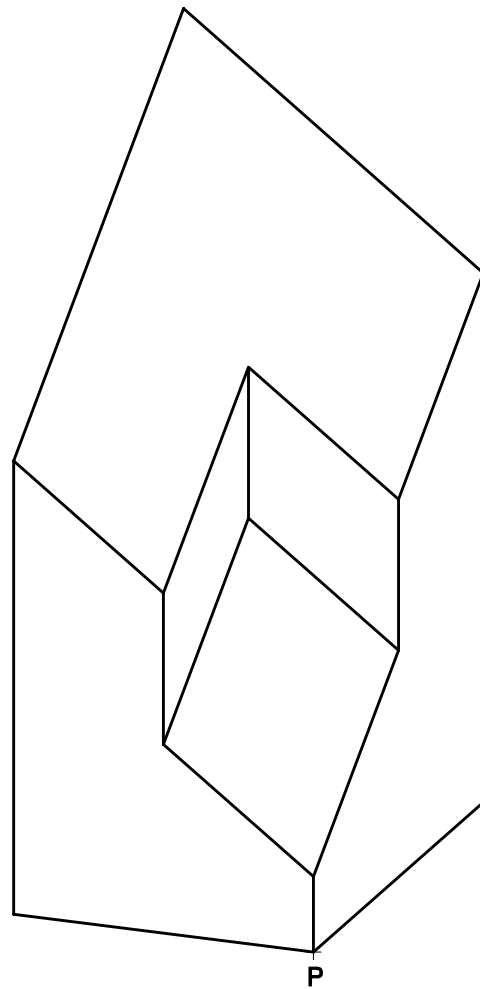
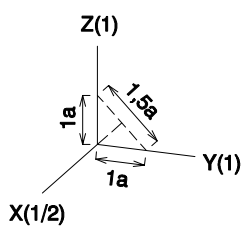
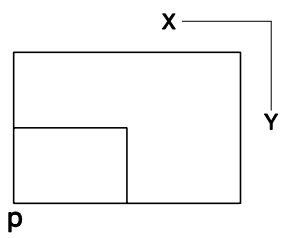
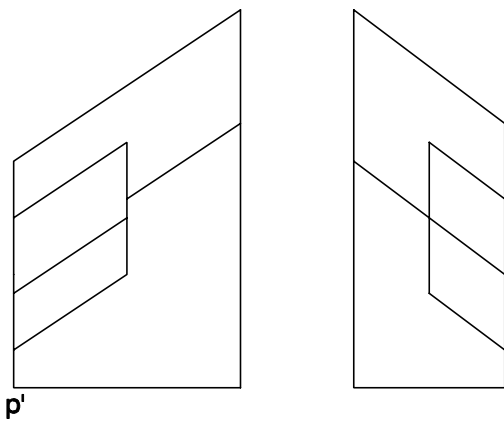

# S1.3B

