

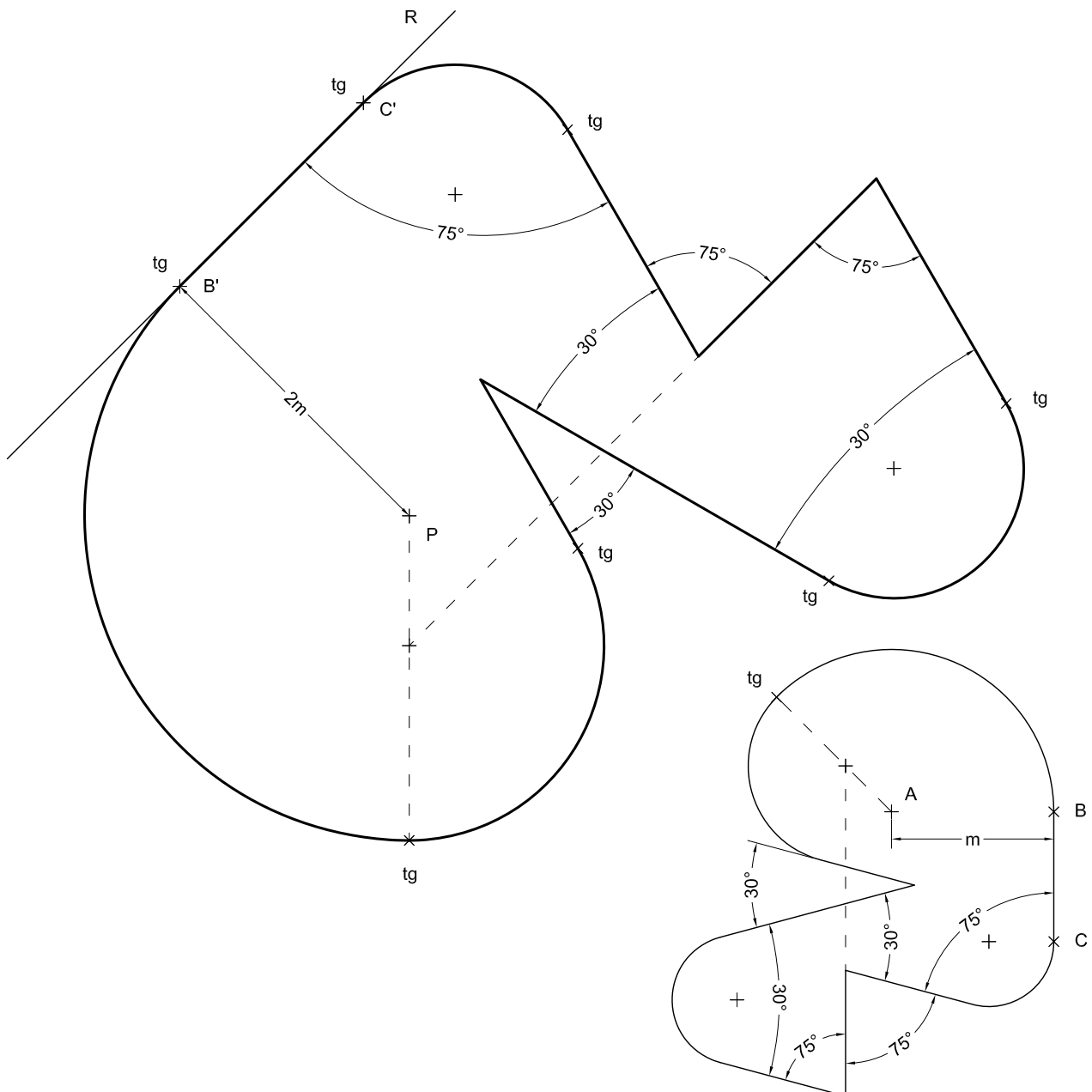

SÈRIE 1

(1-1A)

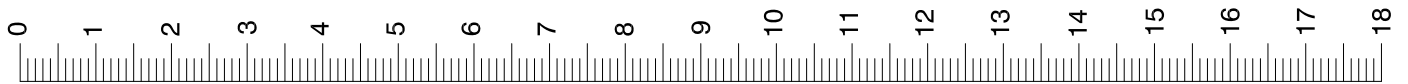



(1-1B)

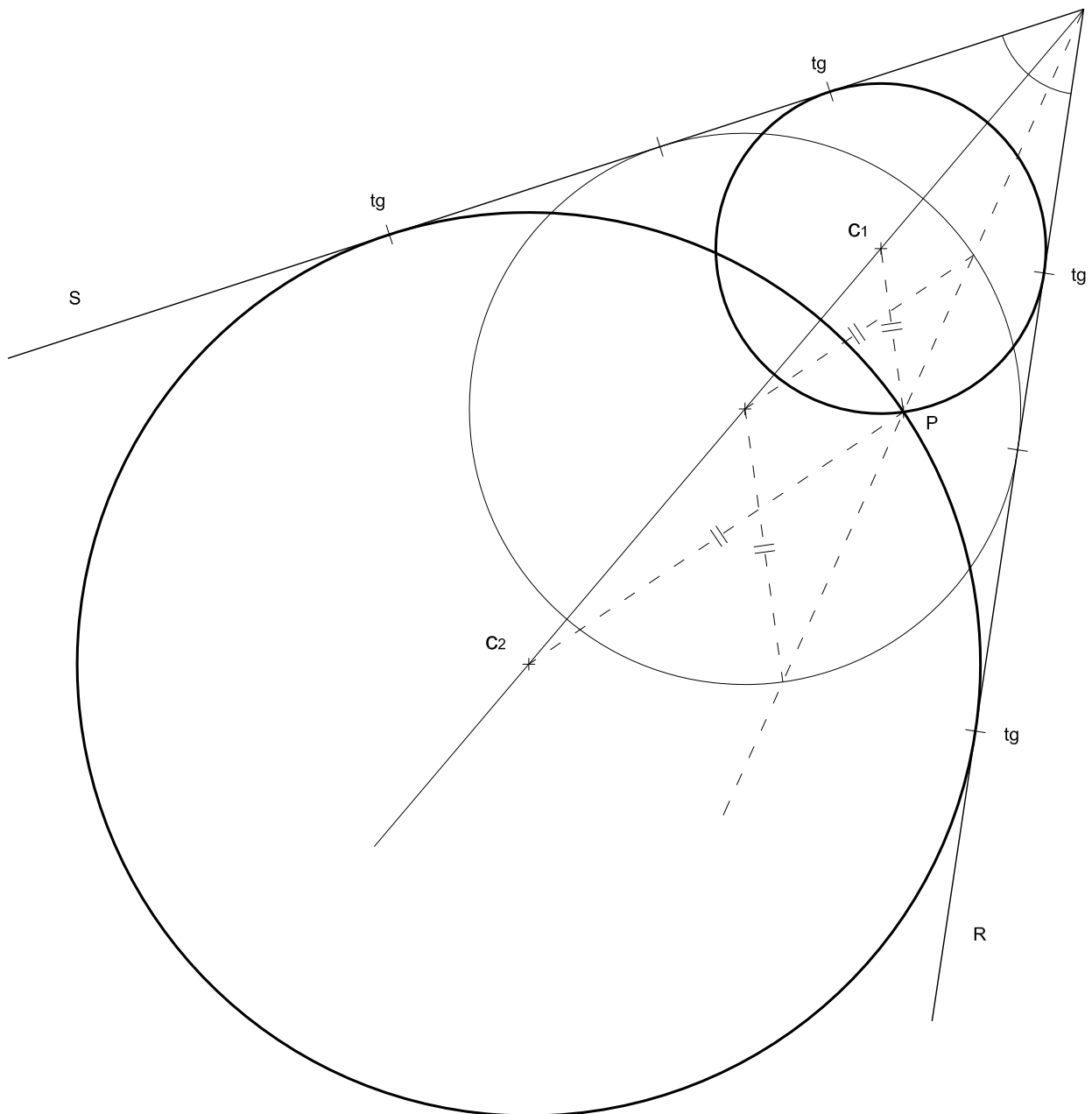
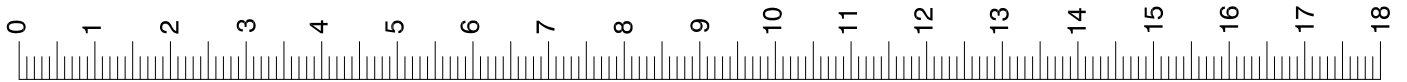



(1-2A)

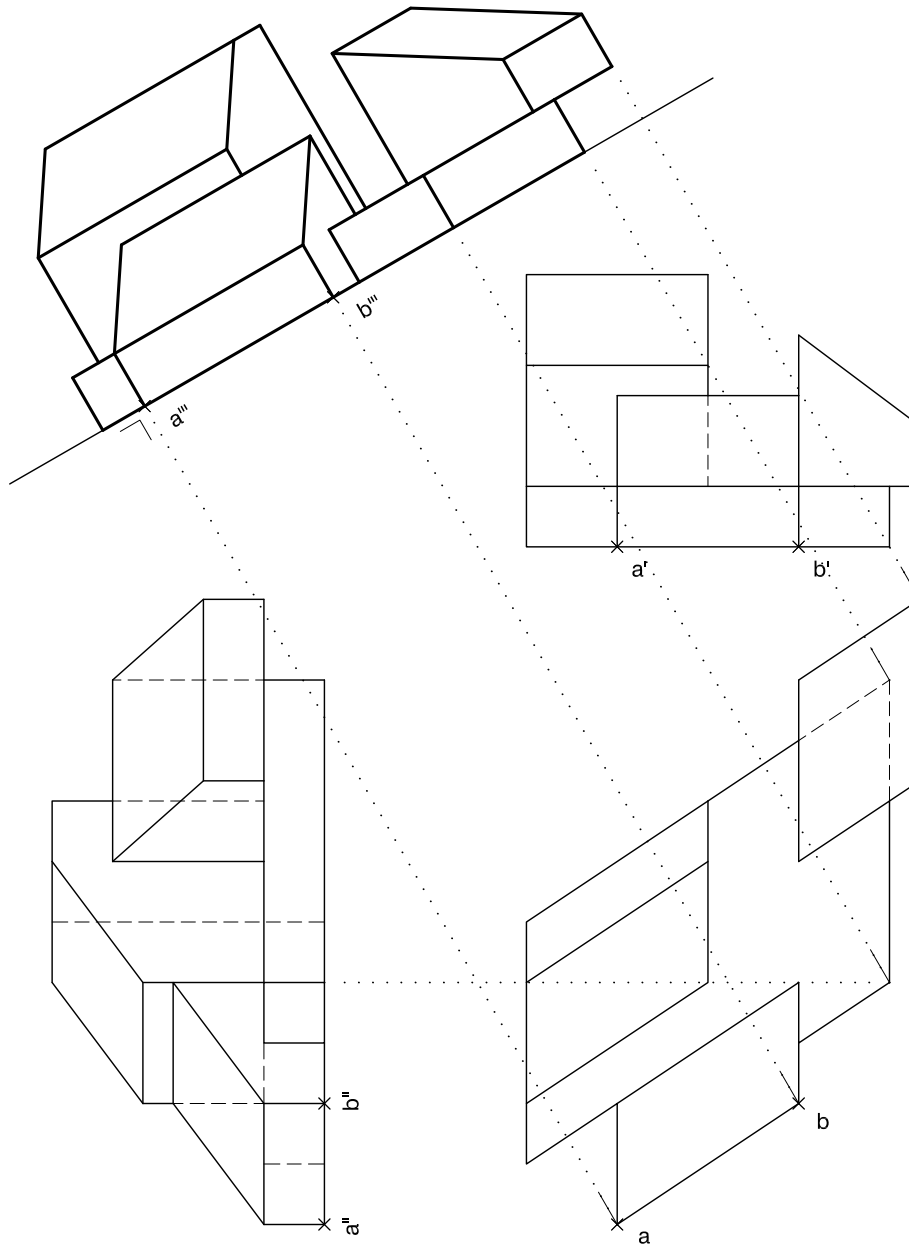
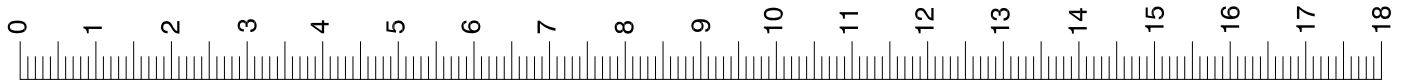



(1-2B)

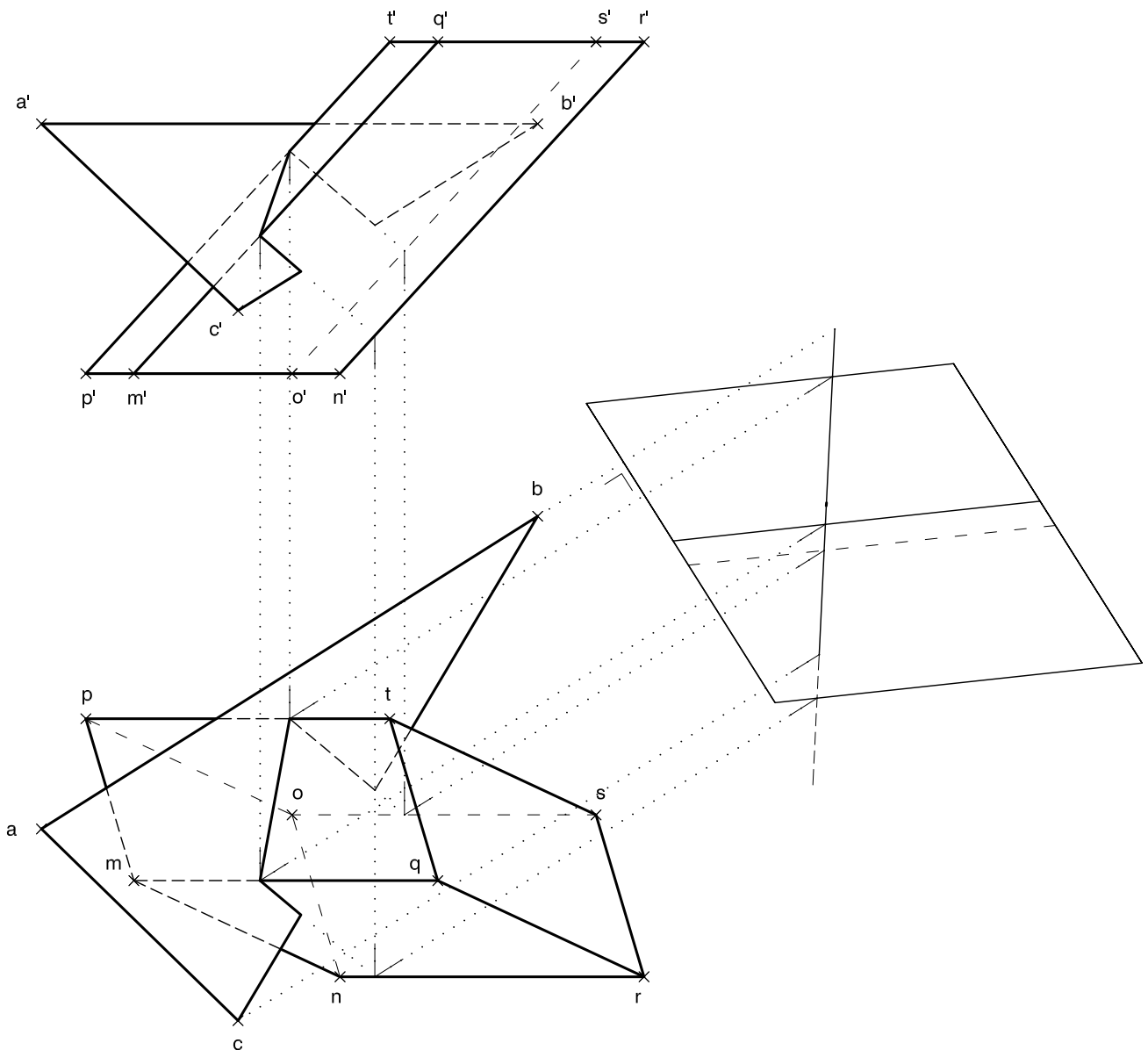



(1-3A)

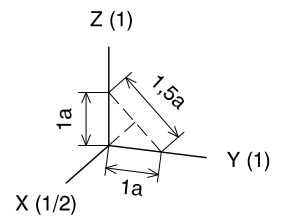
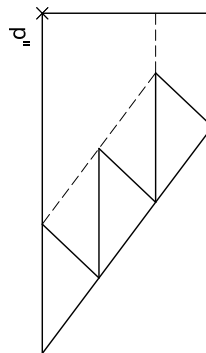
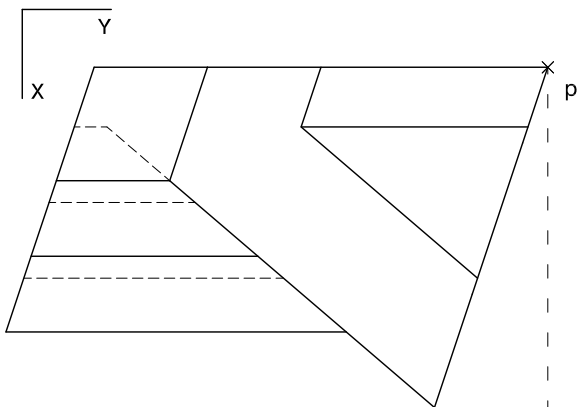
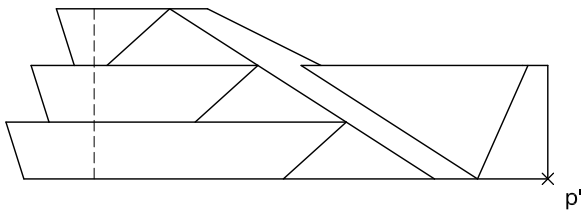
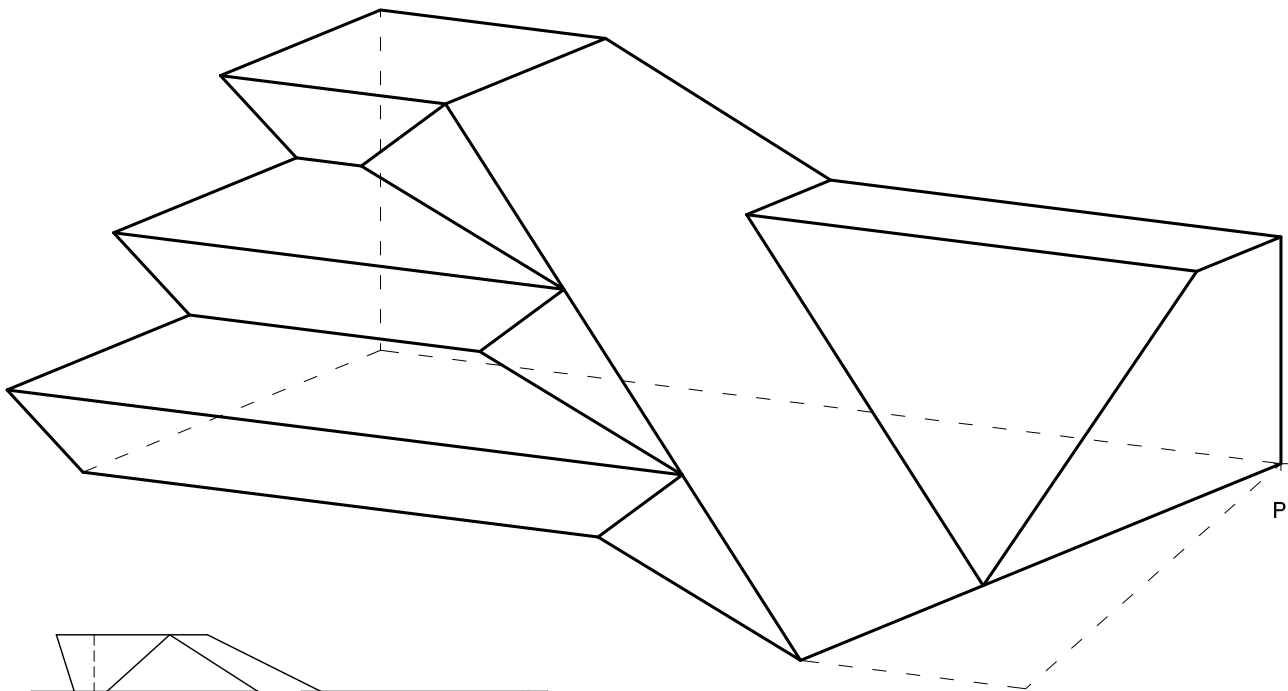
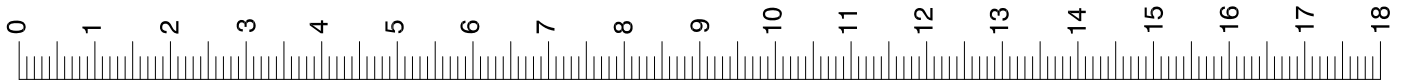



(1-3B)

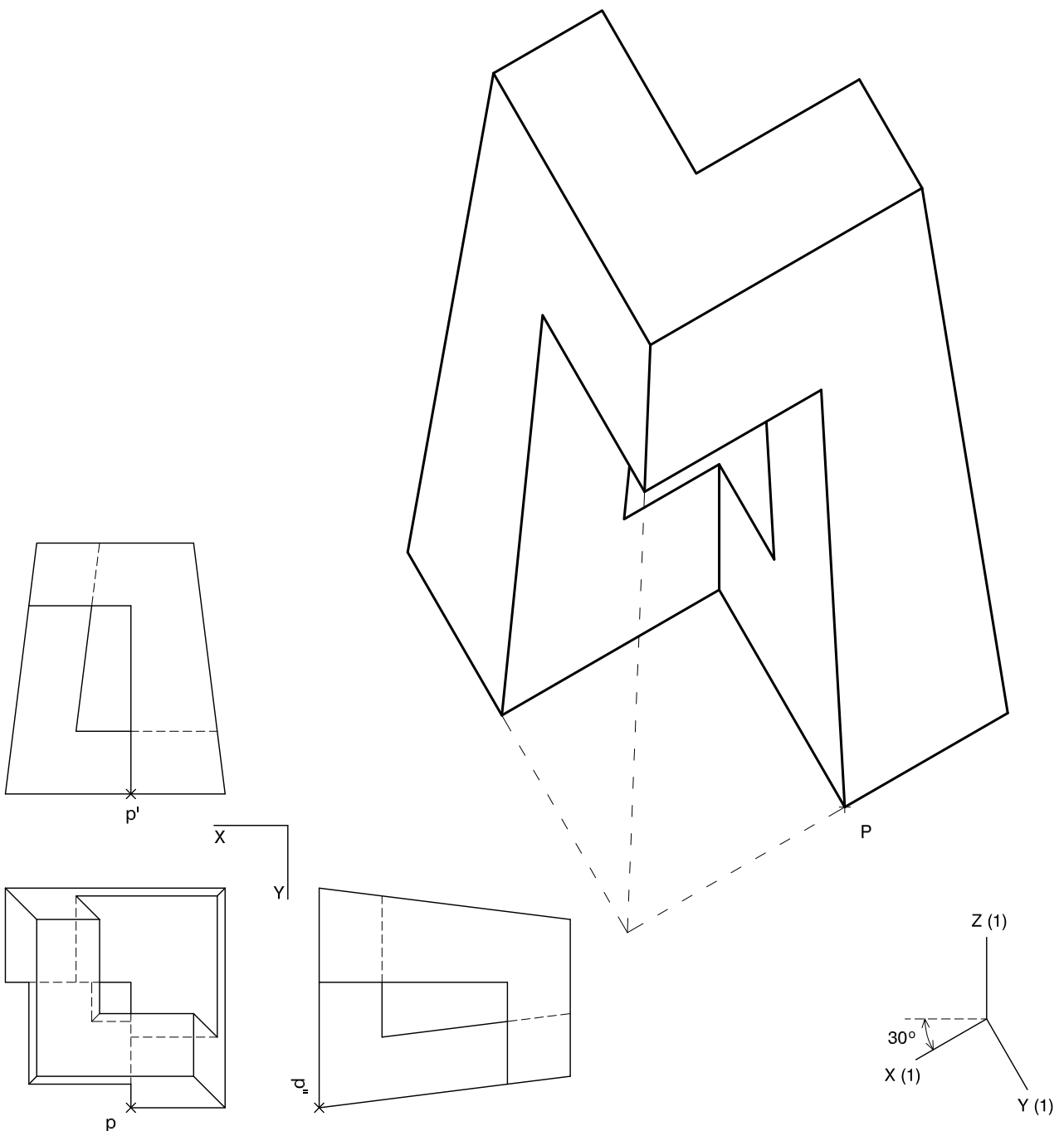
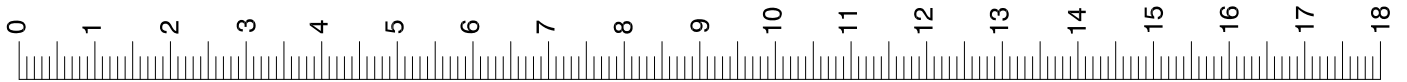



SÈRIE 4

(4-1A)

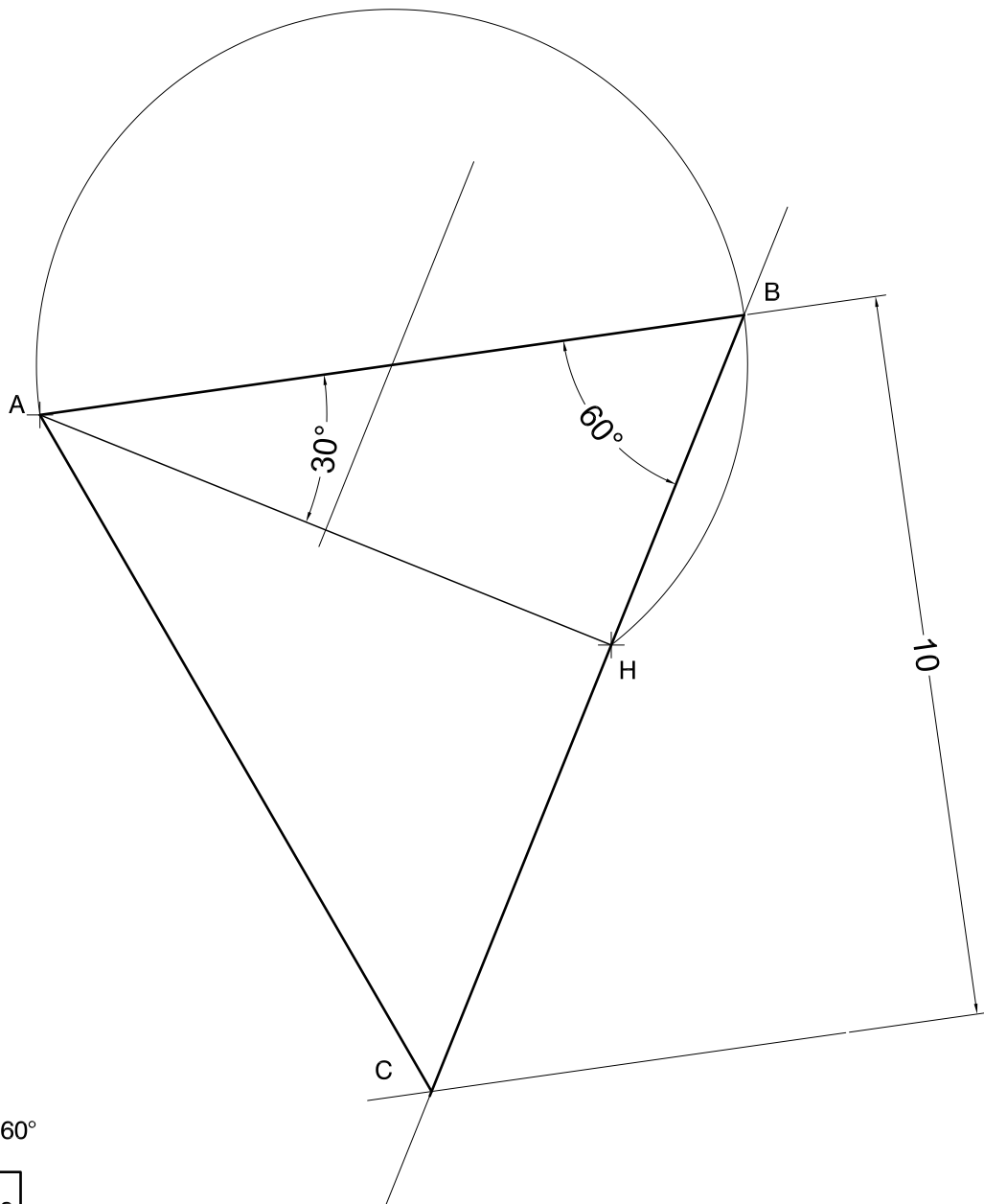
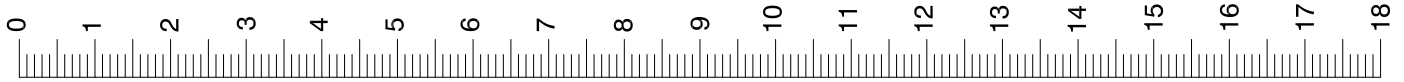

Angle ABC = 60°

10,625 metres

Escala 1:125



(4-1B)

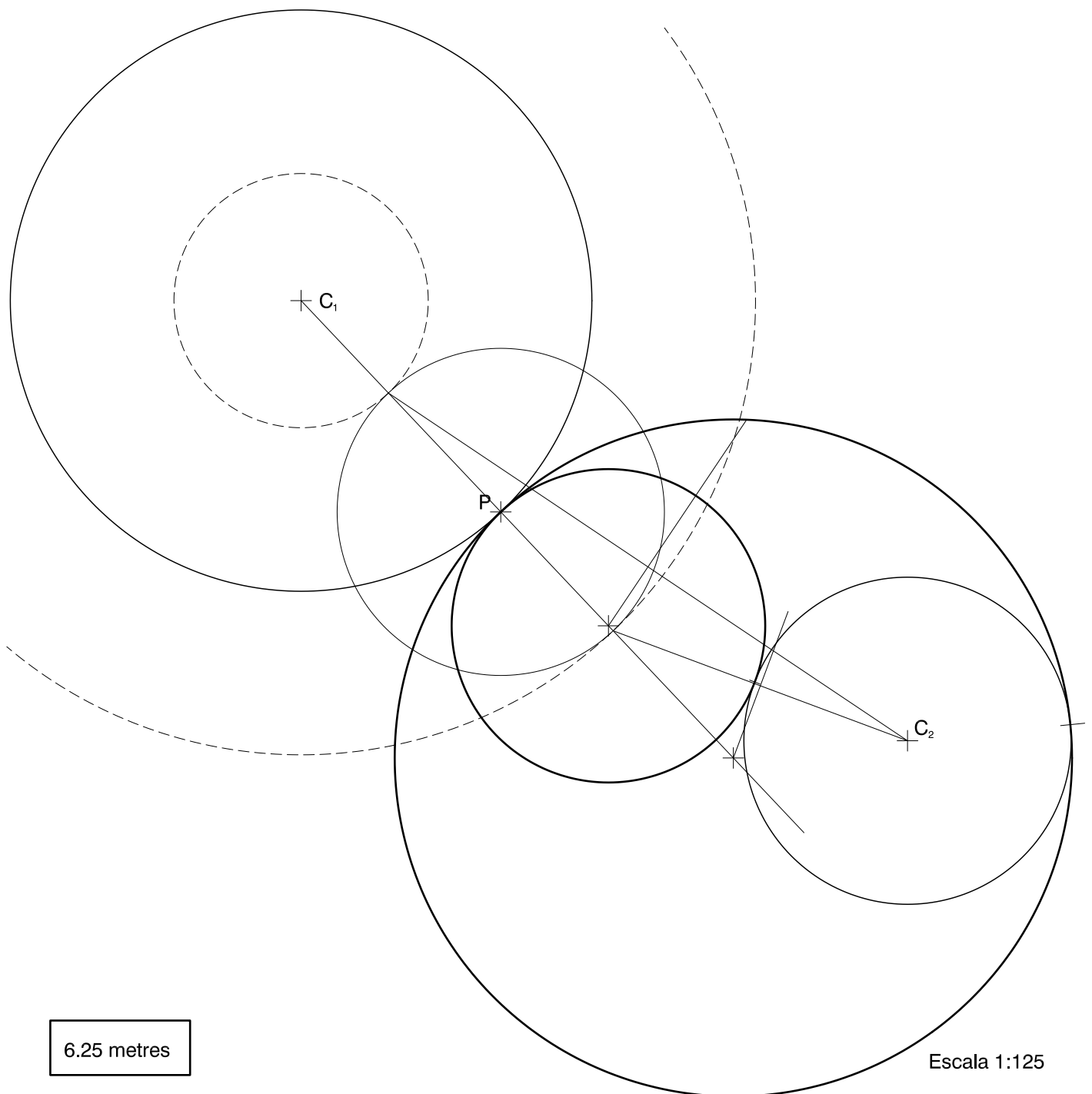
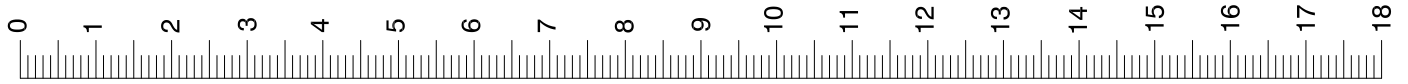

6.25 metres

Escala 1:125



(4-2A)

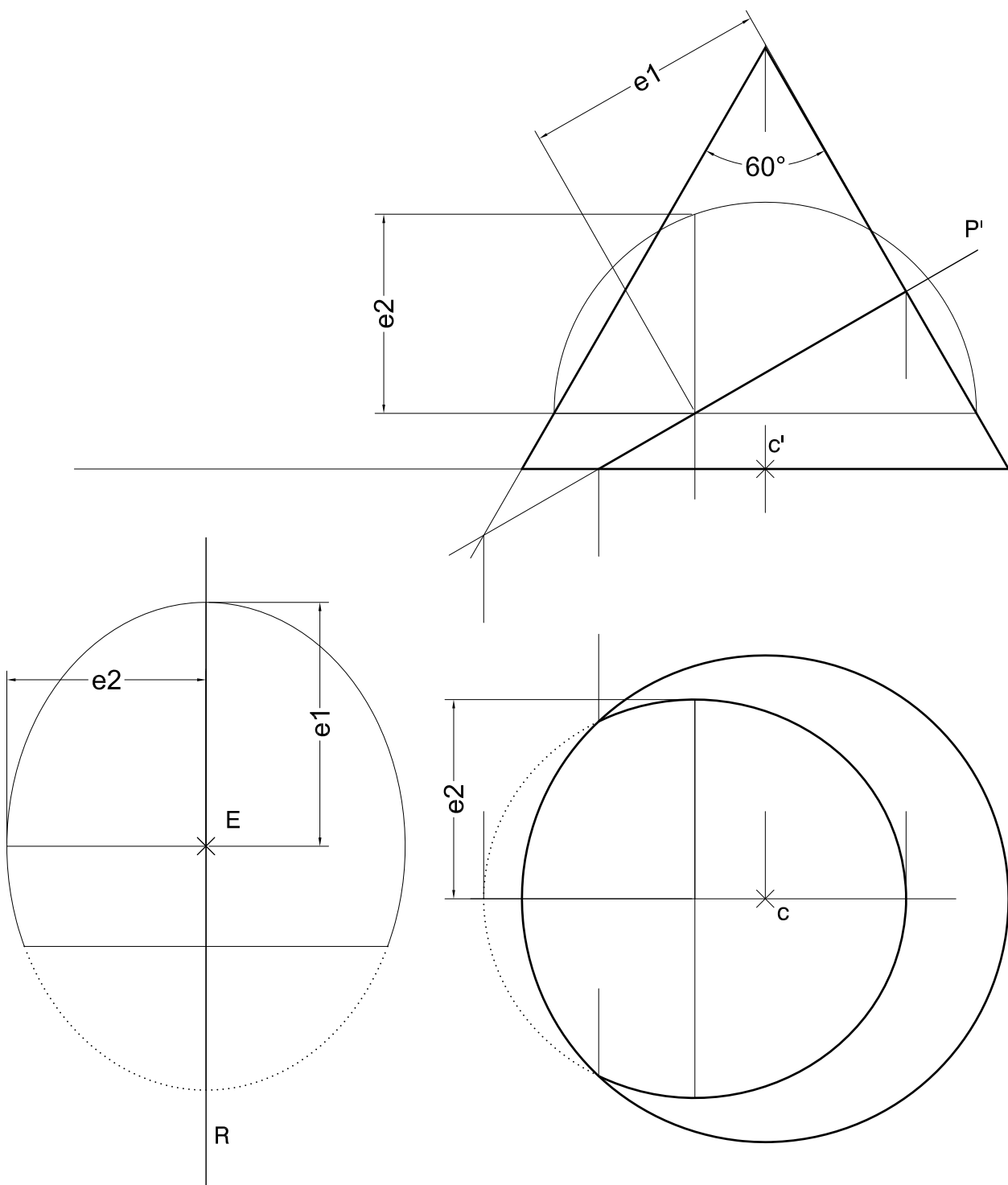



(4-2B)

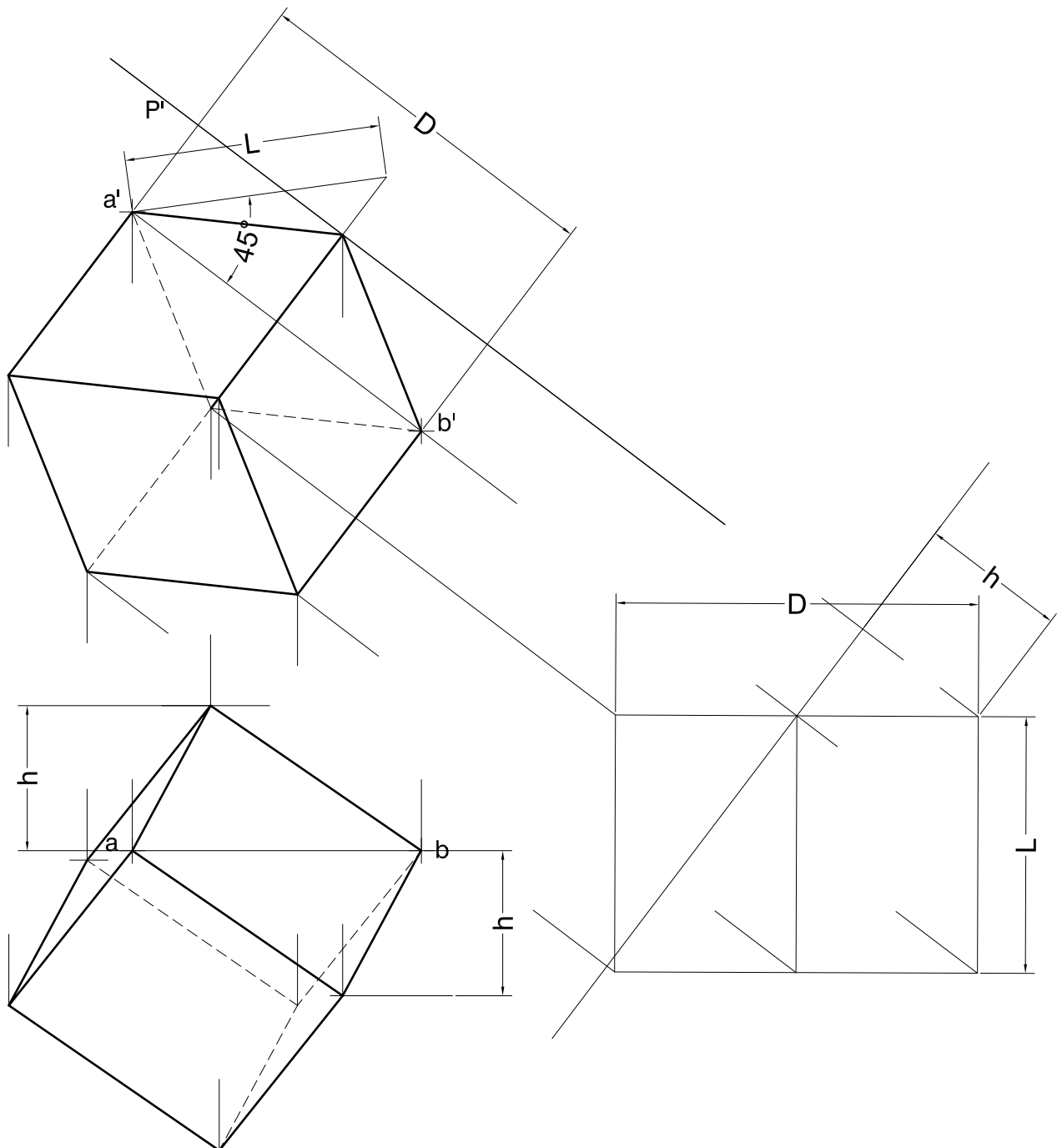
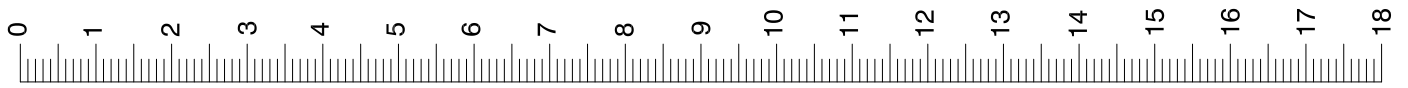



(4-3A)

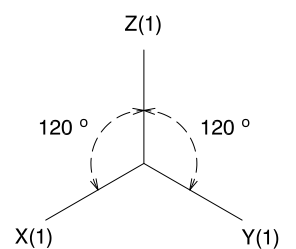
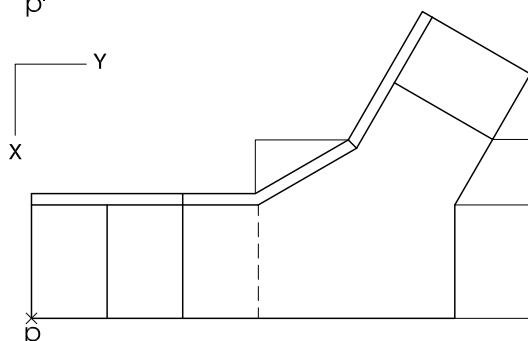
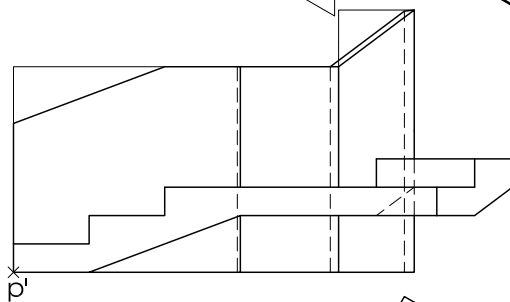
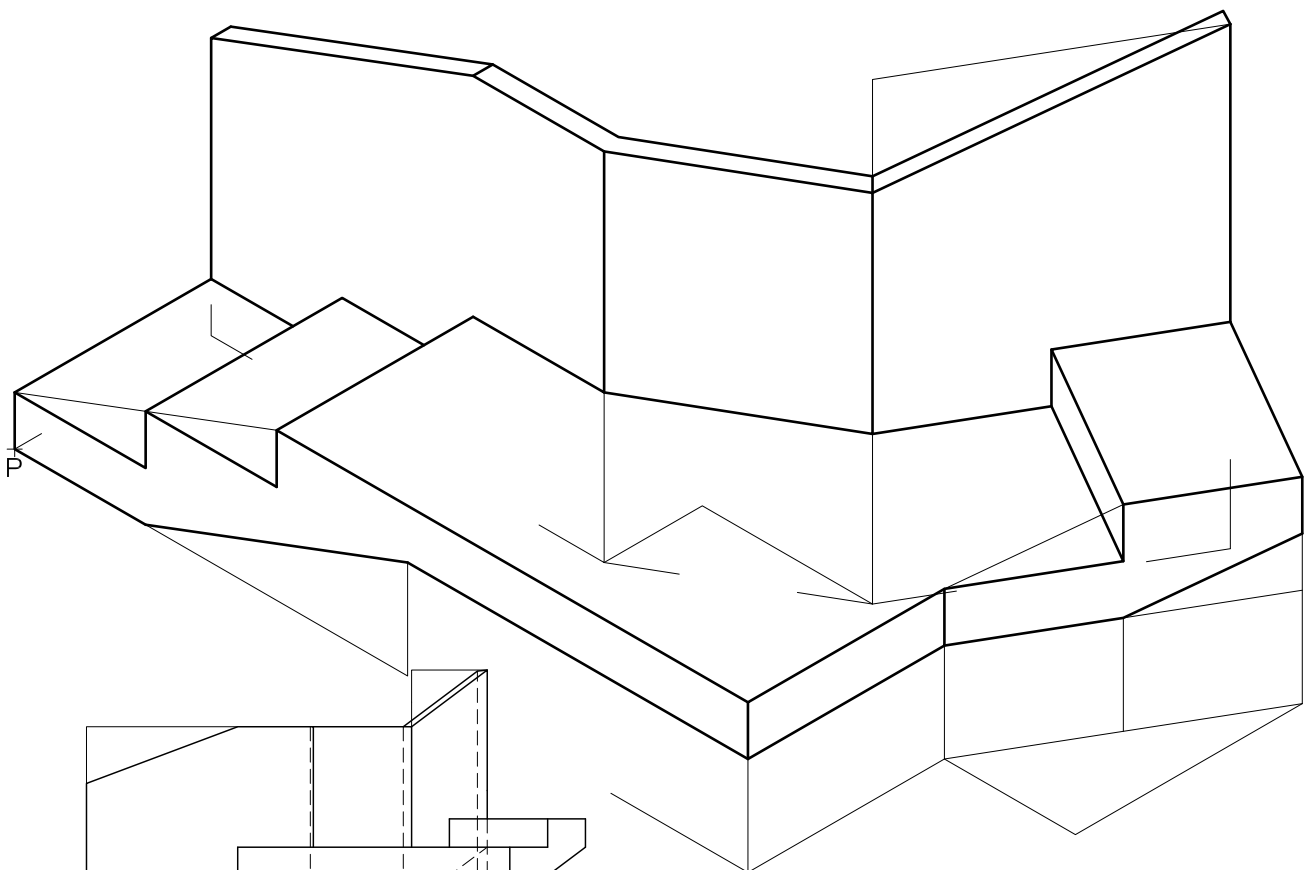
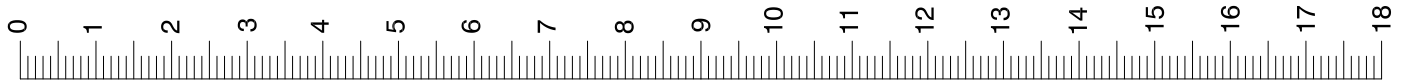



(4-3B)

