

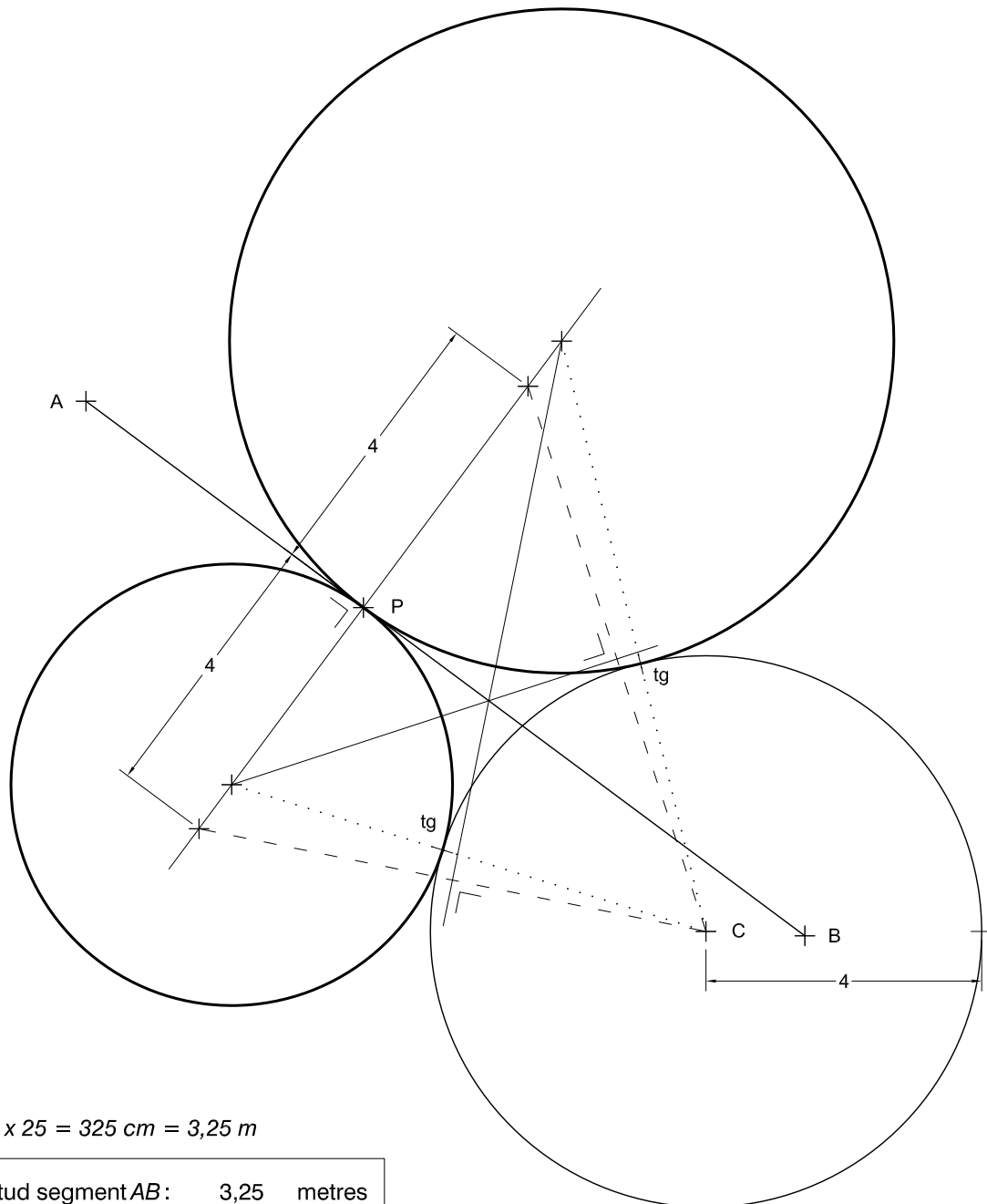

SÈRIE 1

(1-1A)

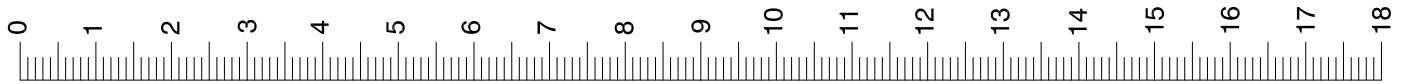

$13\text{ cm} \times 25 = 325\text{ cm} = 3,25\text{ m}$

Longitud segment AB:	3,25	metres
----------------------	------	--------



Proves d'accés a la Universitat 2024, convocatòria ordinària. Criteri específic d'avaluació

(1-1B)

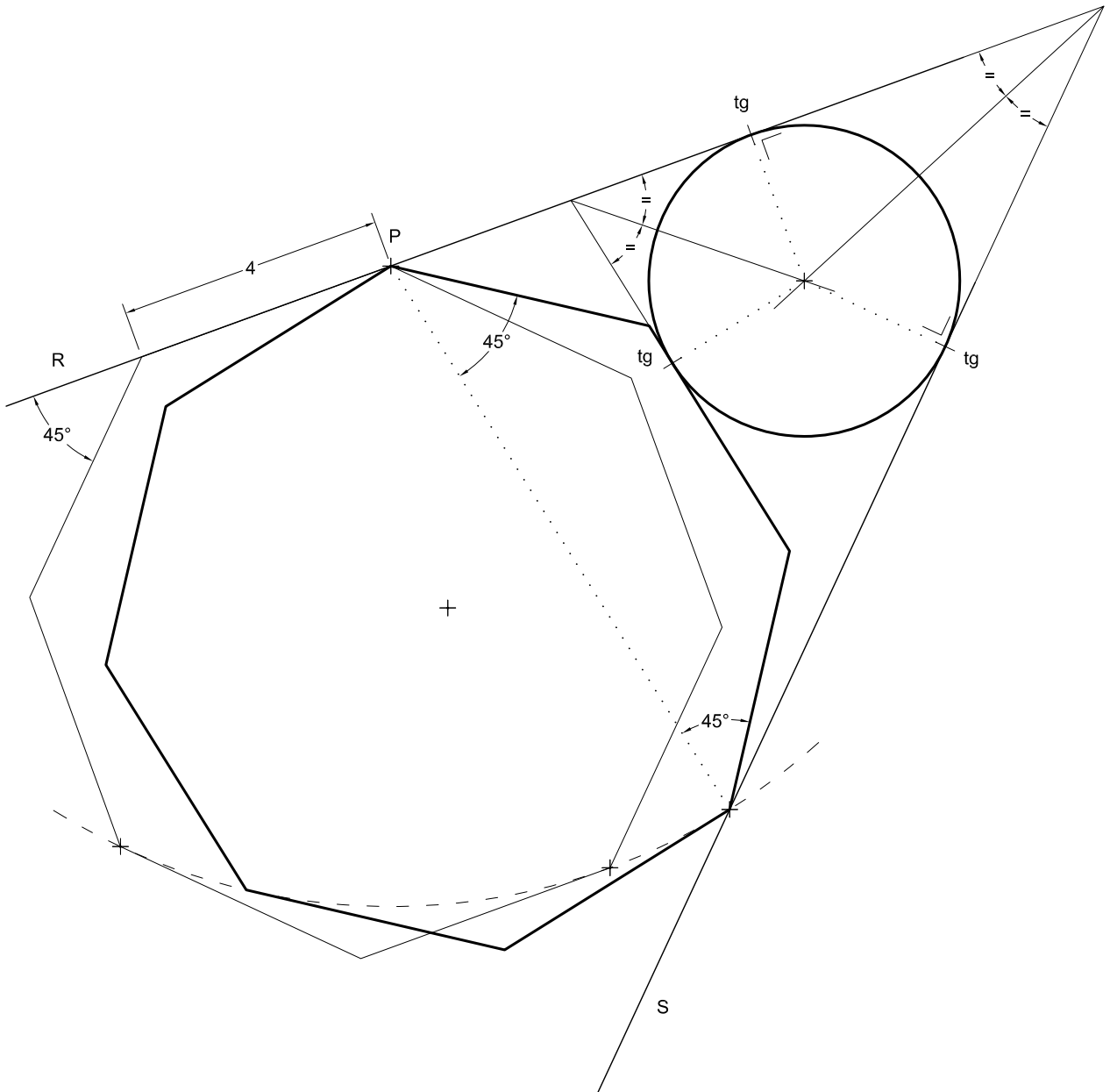
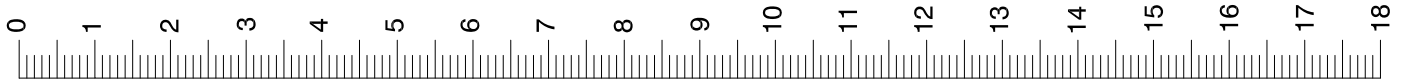



(1-2A)

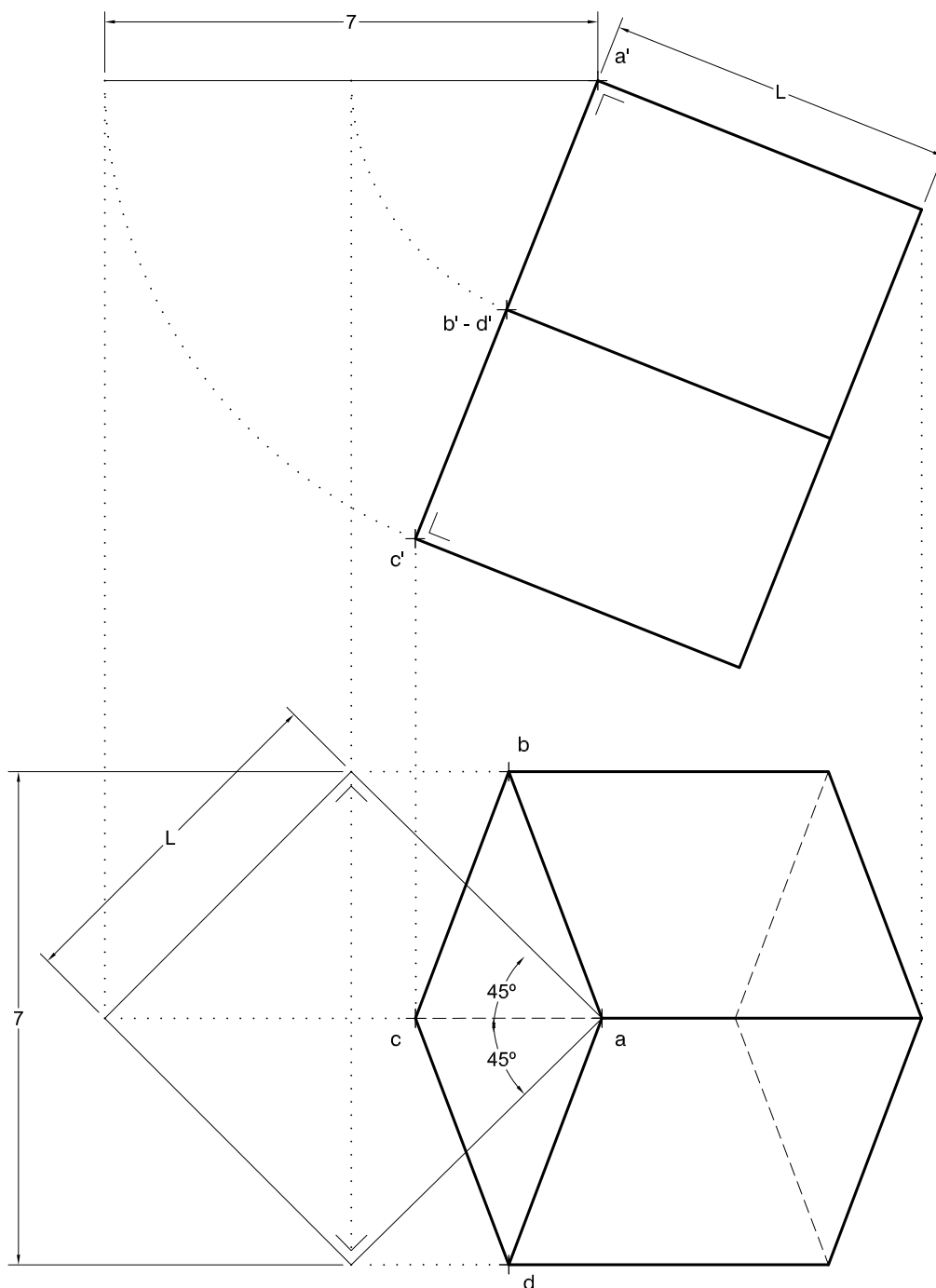
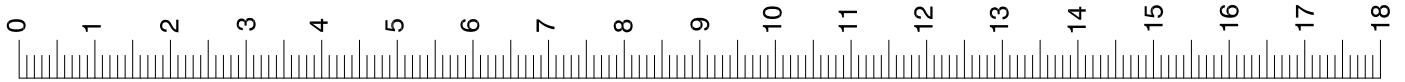



Proves d'accés a la Universitat 2024, convocatòria ordinària. Criteri específic d'avaluació

(1-2B)

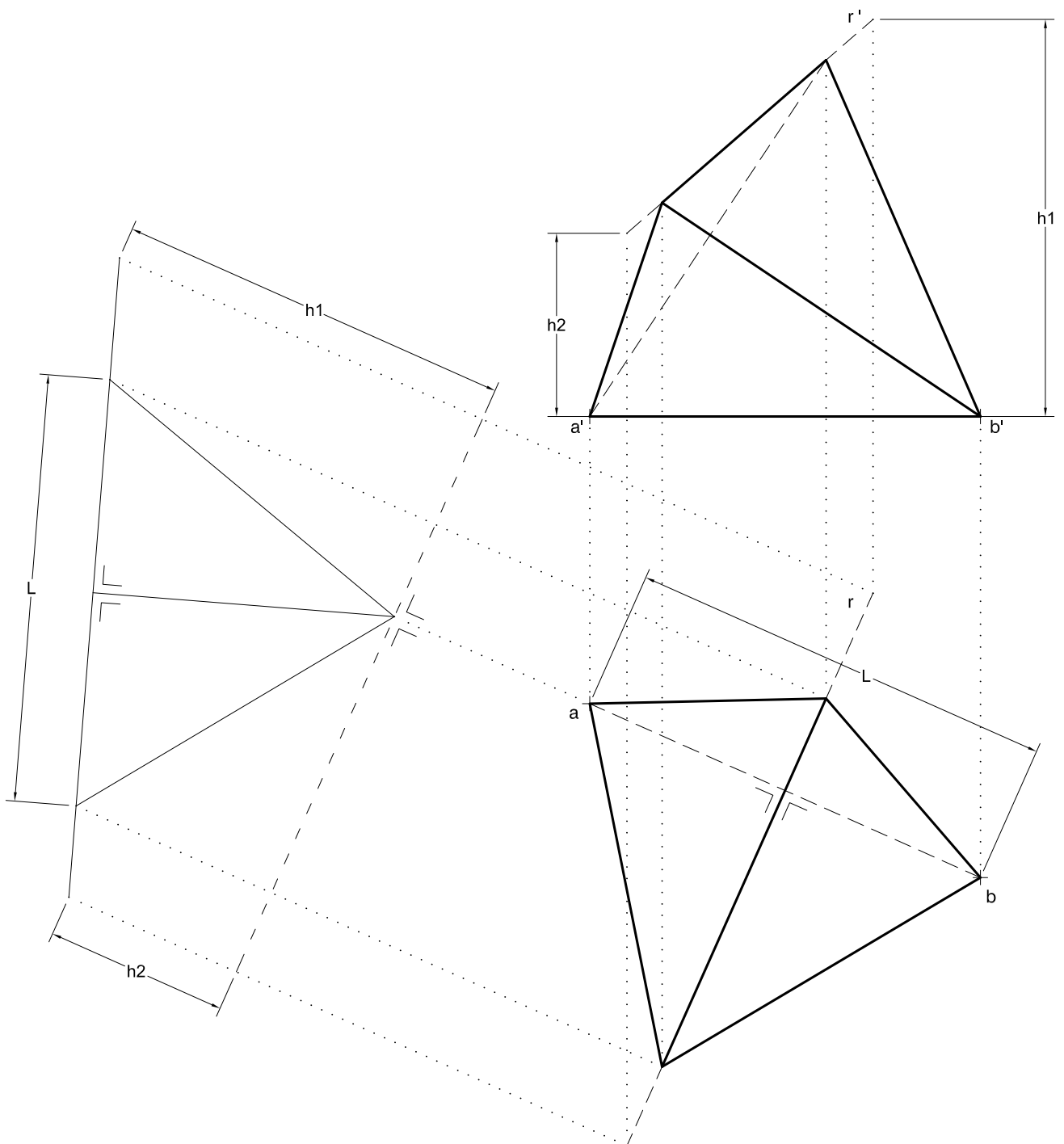
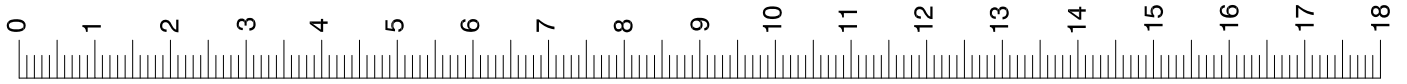



(1-3A)

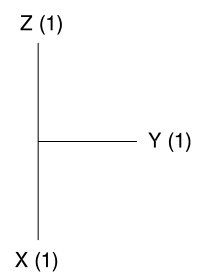
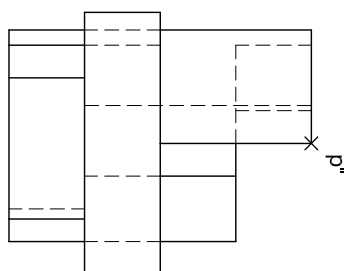
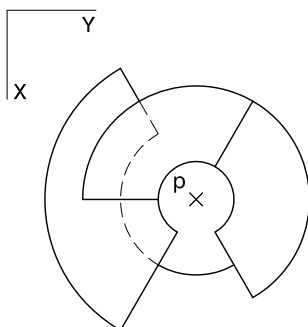
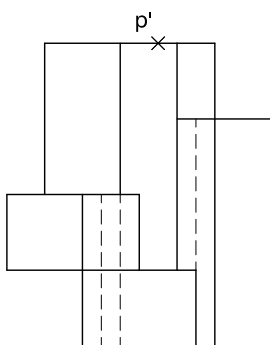
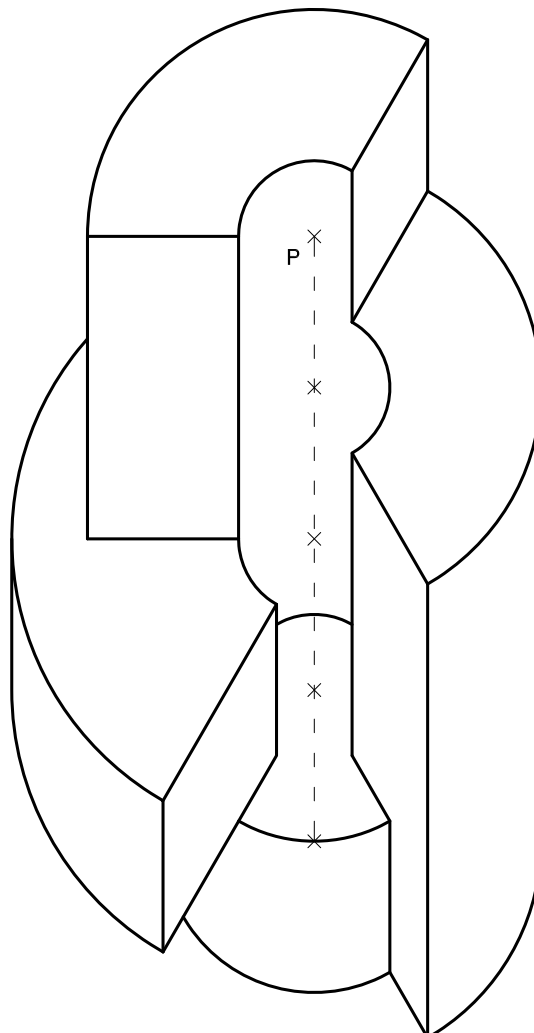
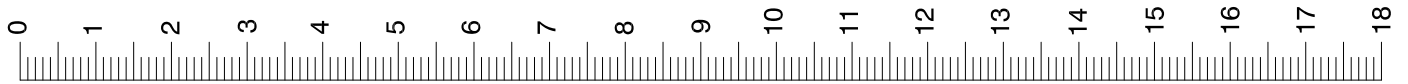



(1-3B)

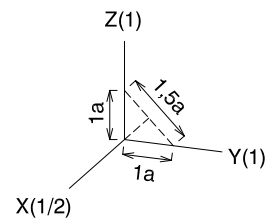
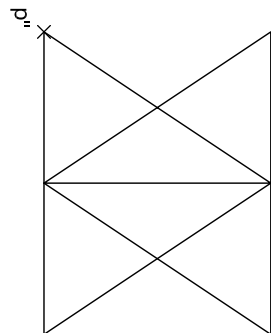
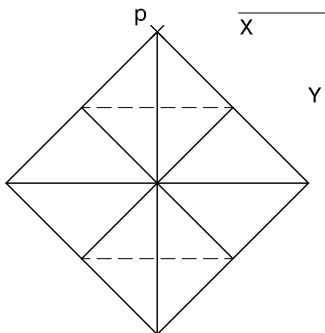
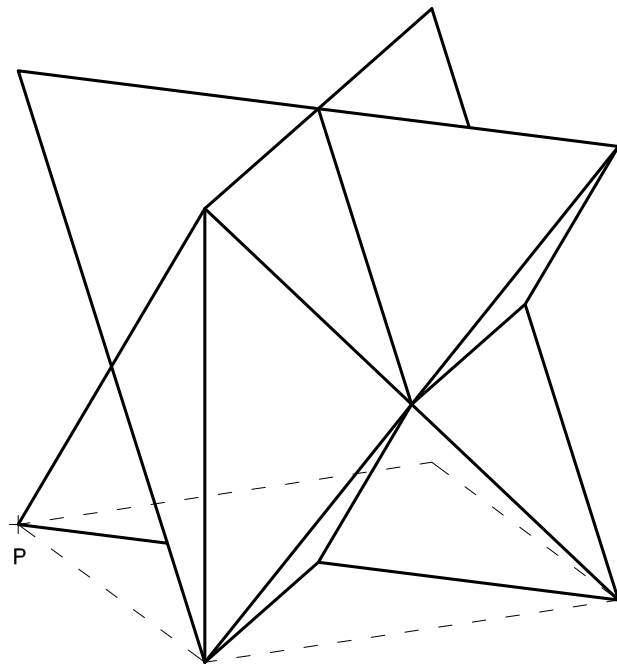
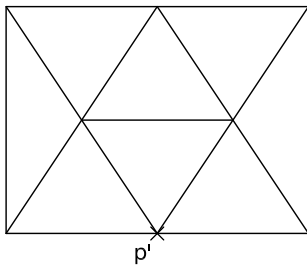
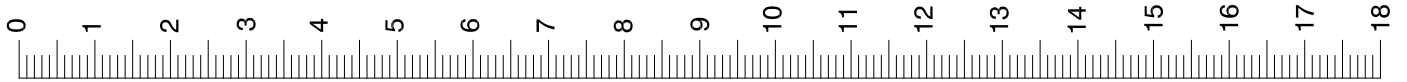

SÈRIE 5

(5-1A)

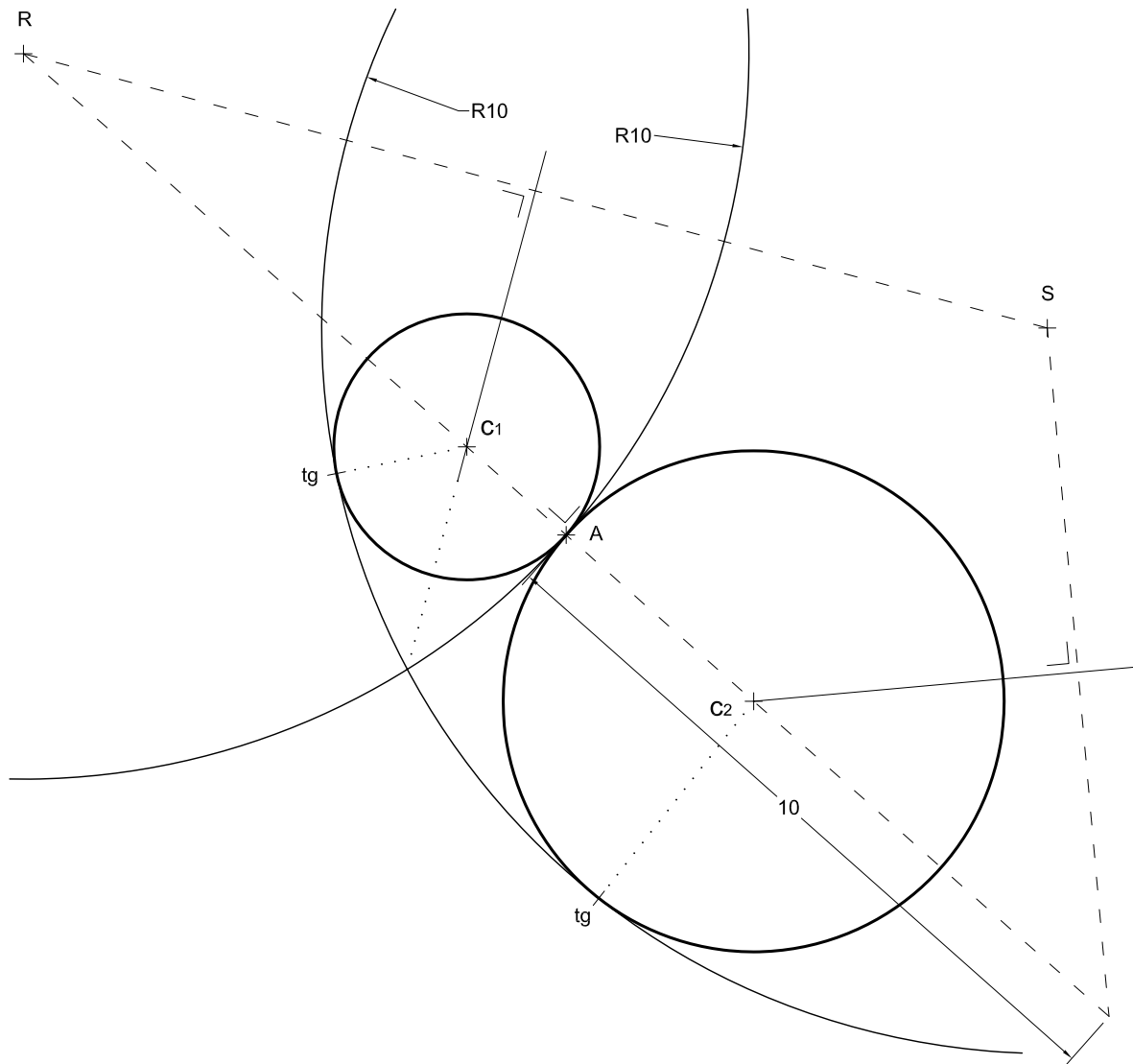
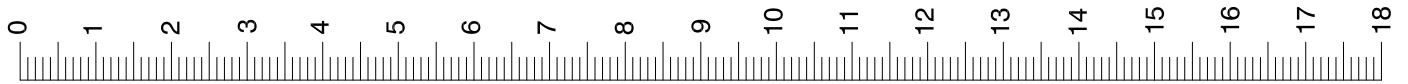



(5-1B)

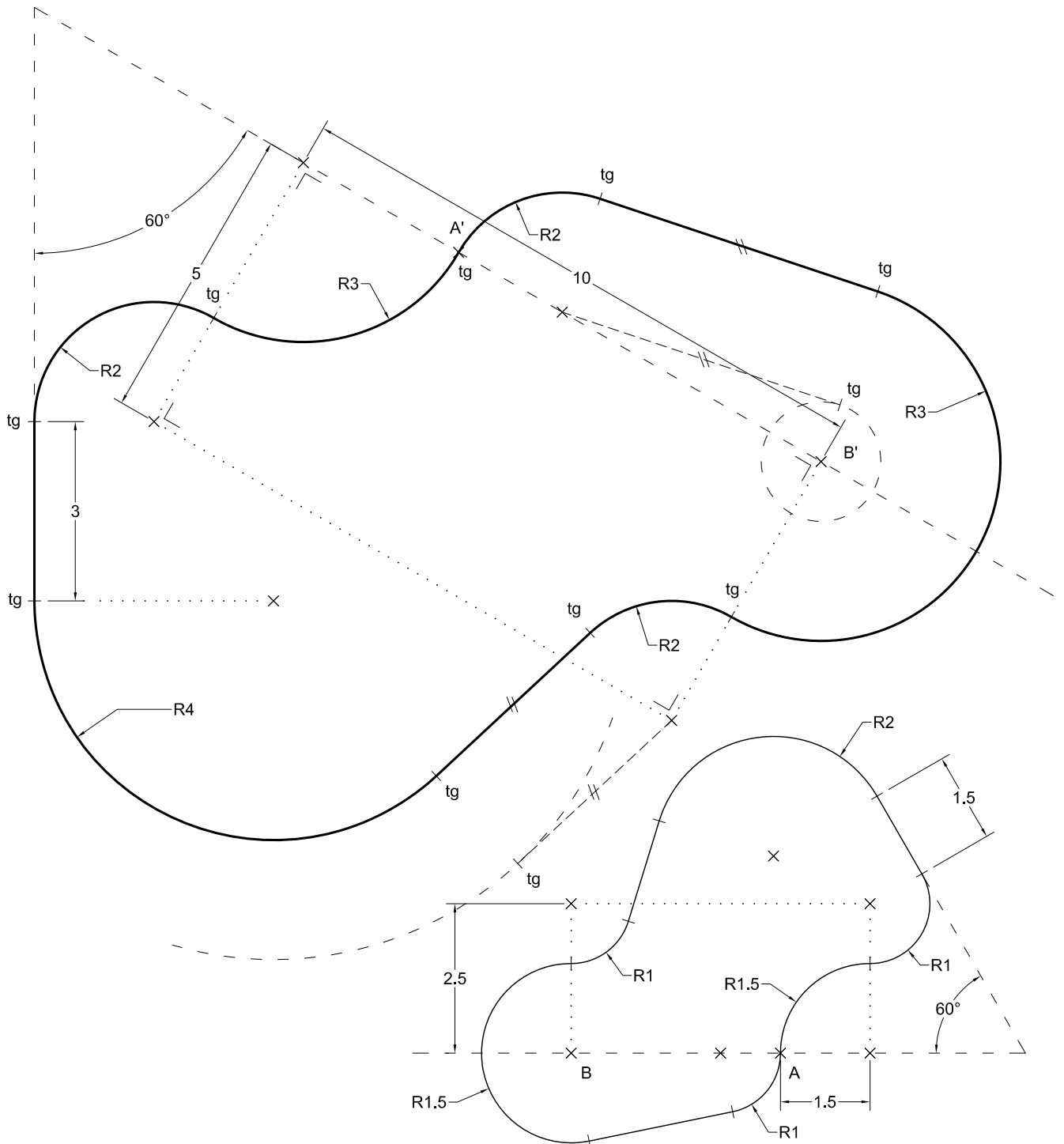
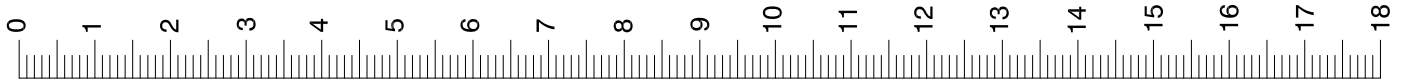

(5-2A)

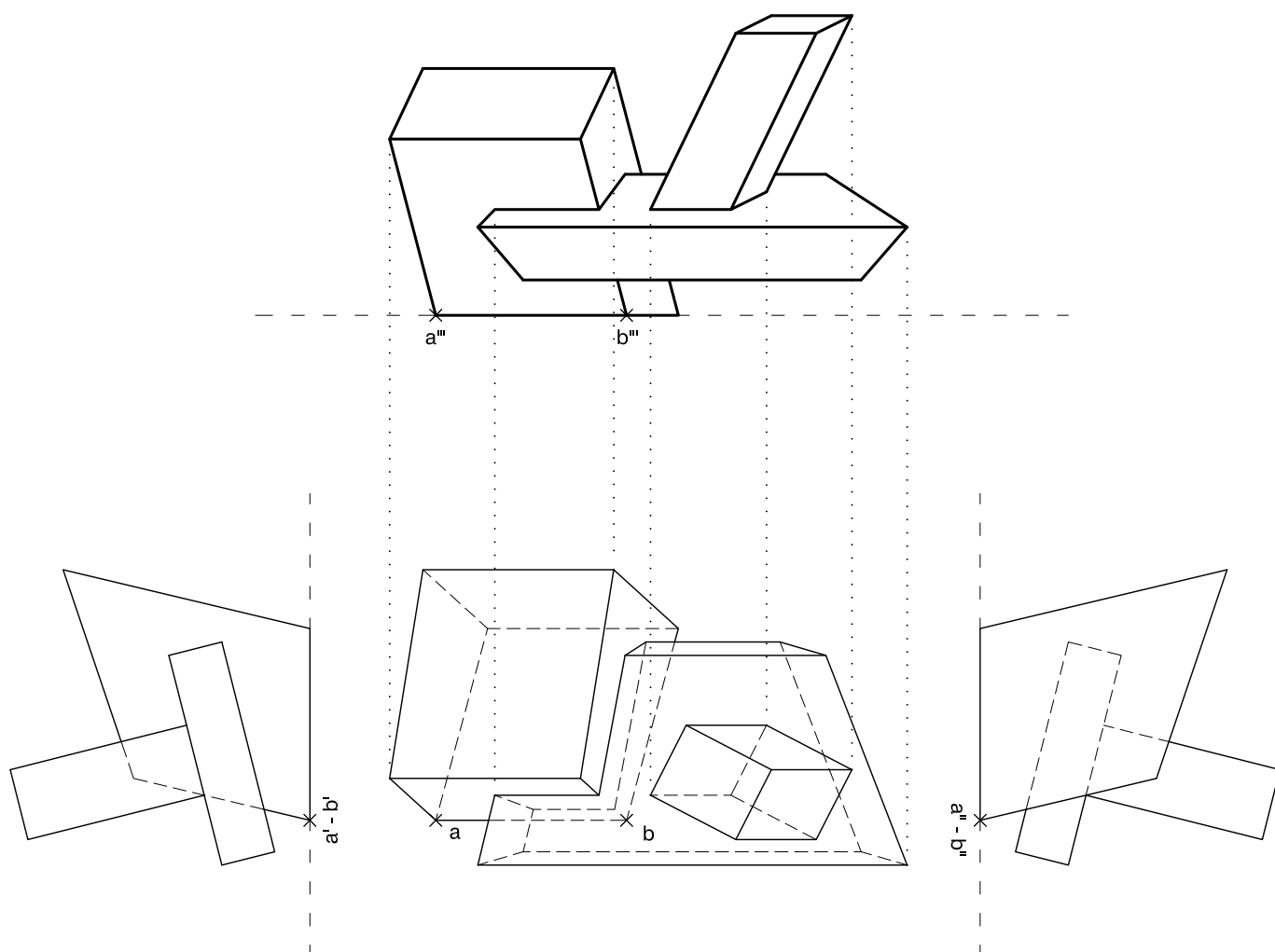



(5-2B)

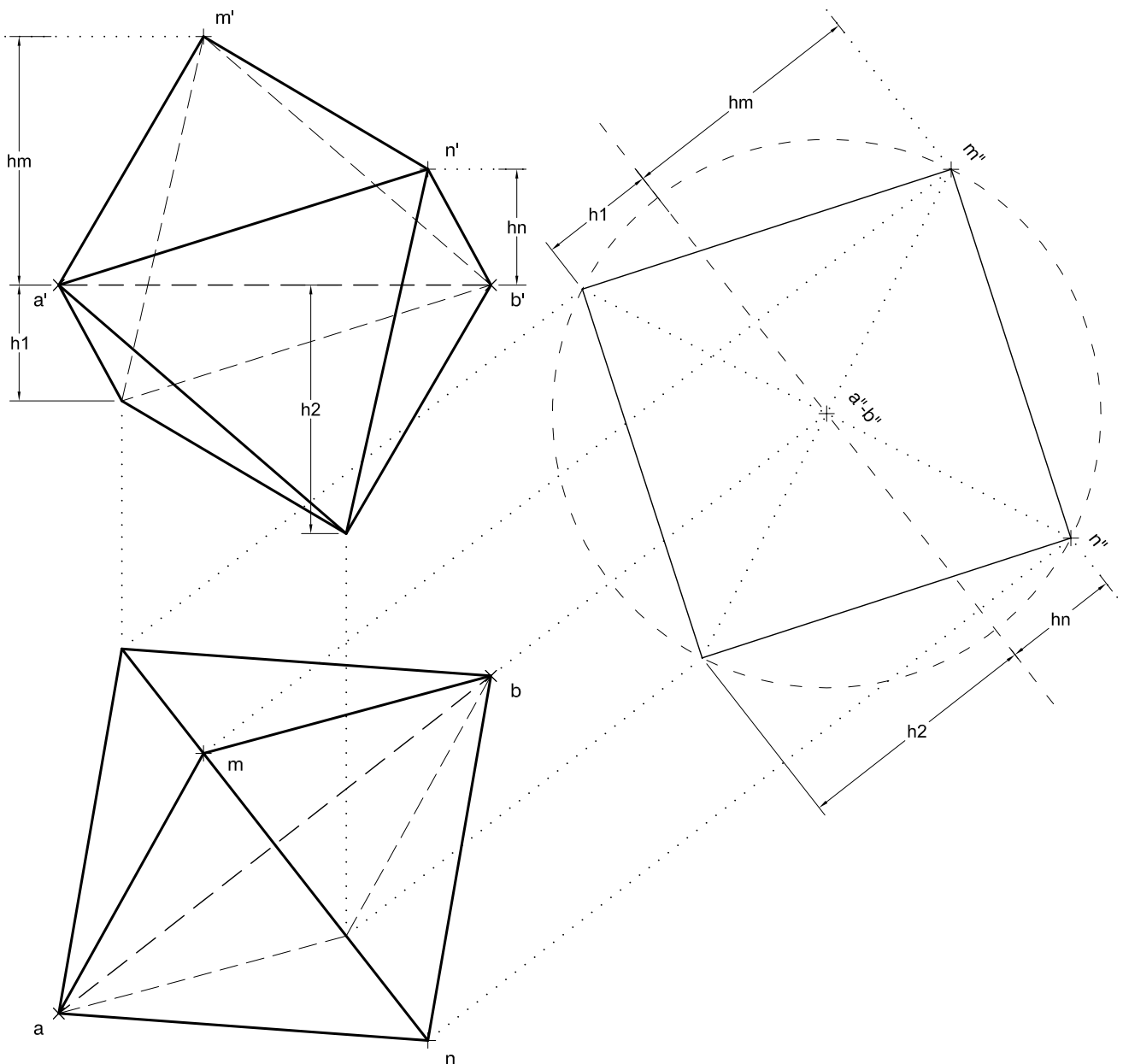
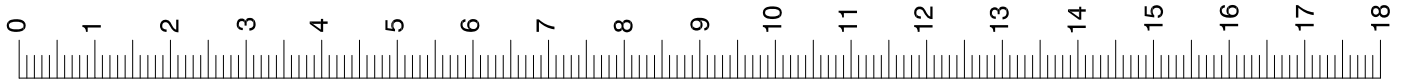



(5-3A)

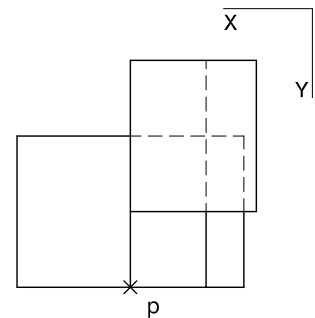
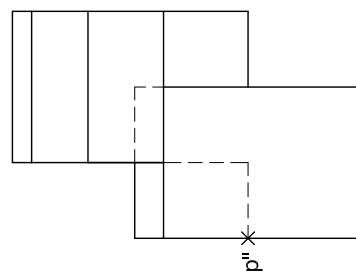
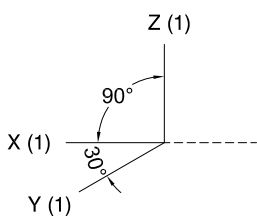
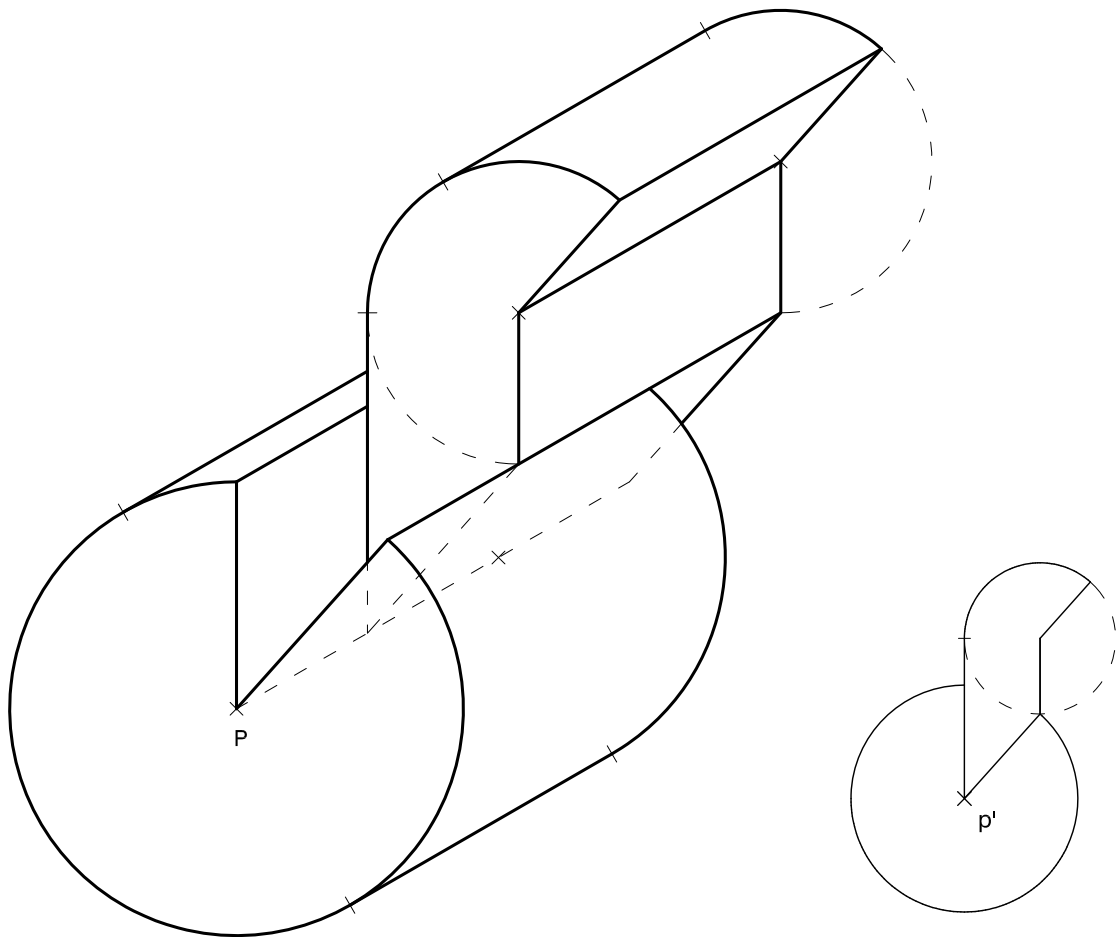
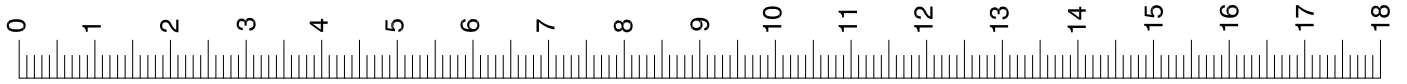



(5-3B)

